

digital keying modular
interface audio
converters analogue video

DDAA132P

SDI to composite or Y/C monitoring
encoder with distribution amplifier

USER MANUAL



Contents

1 Introduction	3
2 Hardware installation	5
2.1 Universal rear connectors	5
Rear module connections with RM01	5
Rear module connections with RM18	6
Rear module connections with RM02	6
2.2 General Purpose Interface (GPI)	8
4U frame GPI connections	9
2U frame GPI Connections	10
1U frame GPI connections	10
DTB-AV GPI connections	11
Indigo DT desk top box GPI connections	11
2.3 Configuration	11
Changing the standard selection mode	12
Changing output signal formats	12
3 Card edge operation	14
4 Problem solving	16
5 Specification	17

1 Introduction

The DDAA132P is an 8 bit serial digital to analogue composite converter with relocked serial and up to four selectable composite or Y/C analogue outputs.

The universal connection system allows a mixture of Crystal Vision modules in the frame. The modules plug in the front, and the rear connectors plug in the back. Depending on frame design, a hinged or removable front panel reveals LED indication of input and PSU status when opened.

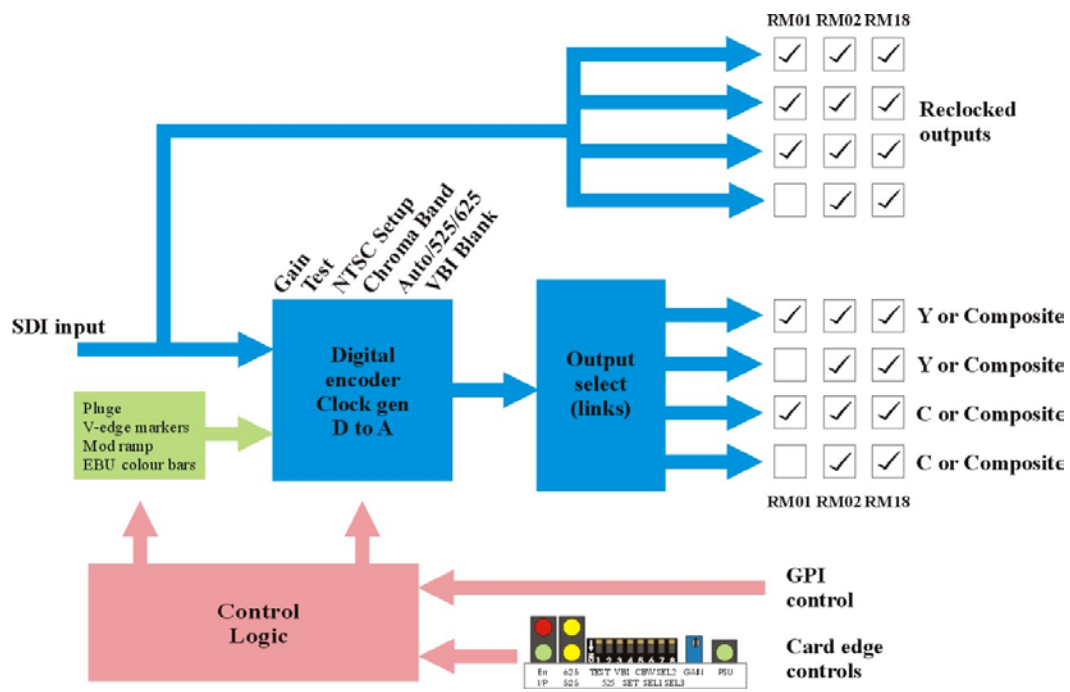

DDAA132P serial digital to analogue converter

The DDAA132P may be used with the RM01 single slot rear connector, the RM02 quadruple slot rear connector and the RM18 double slot rear connector. The RM01 allows the highest frame packing density, with reduced output connections, whilst the RM02 and RM18 provide access to all outputs but with reduced packing density.

The RM01 allows 24 modules in a 4U frame, 12 modules in 2U, six in 1U and two in a desk top box. The RM02 allows 18 modules to fit in a 4U frame, 9 modules in 2U frame and the RM18 allows 12 modules in a 4U frame, six modules in 2U frame, three in 1U and one in a desk top box.

Analogue outputs can be switched between input video and internal test patterns under local or remote (GPI) control. DDAA132P accepts 625 or 525 line input, with automatic detection.

To produce internal test patterns, the DDAA132P requires a valid SDI input signal from which to extract clocking information.

The available test patterns are:

- Pluge
- Vertical edge markers
- Luma/chroma ramp
- EBU colour bars

The main features are:

- 8 bit serial digital to analogue composite converter
- Variable gain
- Automatic equalisation for up to 200 metres of coaxial cable
- Up to four reclocked SDI outputs and four composite or two Y/C outputs
- GPI/LED input presence indication
- Auto or manual PAL 625/NTSC 525 line selection
- VBI blanked or unblanked
- Test patterns or serial input
- NTSC setup on/off and chroma bandwidth select
- Card edge control

Note: This manual covers the DDAA132P. The DDAA132 with only the modulated ramp internal test pattern is also available, along with a dedicated manual.

2 Hardware installation

The DDAA132P serial digital to analogue composite converter fits into all Crystal Vision frames. All modules can be plugged in and removed while the frame is powered without damage.

2.1 Universal rear connectors

When used with a single height rear connector, the 4U Indigo frame will house up to 24 modules and up to three power supplies, the 2U Indigo frame will house up to 12 modules and dual power supplies and the 1U Indigo frame will house six modules and a single power supply. The desk top box has a built in power supply and will house up to two modules with a single height rear connector.

The 4U, 2U and 1U frames have hinged front panels which give access to the PSU and all modules. The desk top boxes have removable fronts. The universal frame wiring system allows any of the interface range of modules to be fitted in any position with the use of removable rear modules.

The DDAA132P may be used with the RM01 single slot rear connector, the RM02 quadruple slot rear connector and the RM18 double slot rear connectors.

Rear module connections with RM01

RM01 fits in all frames		Description
		RM01 <ul style="list-style-type: none"> • 24 modules in 4U, 12 modules in 2U, six in 1U and two in a desk top box • All frame slots can be used
BNC	Connection	
PAL/NTSC/C	Composite video or C (set by PL4)	
SDI IN	Serial digital input	
SDI OUT(1)	Reclocked serial digital output	
SDI OUT(2)	Reclocked serial digital output.	
SDI OUT(3)	Reclocked serial digital output	
PAL/NTSC/Y	Composite video or Y plus Sync (set by PL5)	

Rear module connections with RM18

RM18 fits in all frames	Description
<p style="text-align: center;">RM18</p>	<p>RM18</p> <ul style="list-style-type: none"> • 12 modules in 4U, six modules in 2U, three in 1U, one in a desk top box • One module per rear connector • Nine connections available • Card fits in upper slot • No card fits in lower slot

BNC	Connection
N/C	No connection
SDI IN	Serial digital input
SDI OUT	Reclocked serial digital output
PAL/NTSC/C	Composite video or C (set by PL2)
PAL/NTSC/Y	Composite video or Y plus sync (set by PL5)
PAL/NTSC/Y	Composite video or Y plus sync (set by PL3)
N/C	No connection
SDI OUT	Reclocked serial digital output
SDI OUT	Reclocked serial digital output
SDI OUT	Reclocked serial digital output
N/C	No connection
PAL/NTSC/C	Composite video or C (set by PL4)

Rear module connections with RM02

RM02 fits in a 4U or 2U Indigo frame	Description
<p style="text-align: center;">RM02</p>	<p>RM02</p> <ul style="list-style-type: none"> • 18 modules per 4U frame, nine modules per 2U frame • Three modules per rear connector • Nine connections available • Card 1 fits in slots 1, 5 and 9 (1, 5, 9, 13, 17 and 21 in 4U) • Card 2 fits in slots 2, 6 and 10 (2, 6, 10, 14, 18 and 22 in 4U) • Card 3 fits in slots 4, 8 and 12 (4, 8, 12, 16, 20 and 24 for 4U) • No card fits in 3, 7 or 11 (3, 7, 11, 15, 19, 23 for 4U)

BNC		Single channel configuration
SDI IN		Serial digital input
1		Reclocked serial digital output
2		Reclocked serial digital output
3		Reclocked serial digital output
4		Reclocked serial digital output
PAL/NTSC/C		Composite video or C (set by PL2)
PAL/NTSC/Y		Composite video or Y plus Sync (set by PL3)
PAL/NTSC/C		Composite video or C (set by PL4)
PAL/NTSC/Y		Composite video or Y plus Sync (set by PL5)

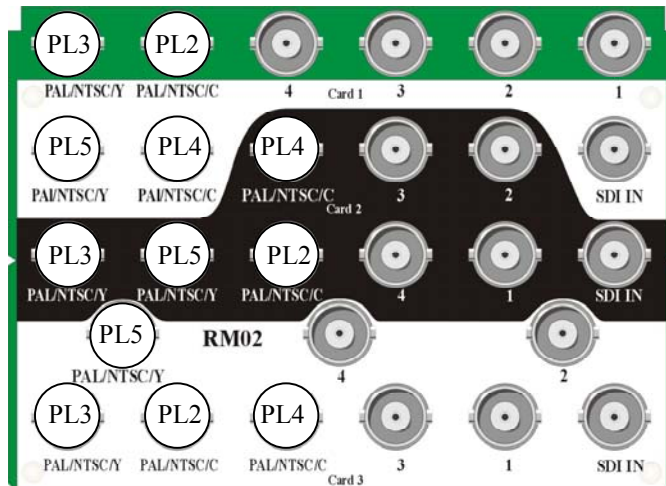

RM02 output configuration showing link settings.

For detailed link information see board configuration.

2.2 General Purpose Interface (GPI)

The external GPI control lines 'a' to 'f' at the frame remote connectors may be used to control the DDAA132P remotely with (say) remote switches emulating some of the front panel switches. The GPI lines are normally pulled up on board to +5V via 10kΩ and will withstand up to +35V.

GPI connections

	Open	Connect to ground
'a'	No setup	Adds 7.5 IRE of setup to Y & reduces Y gain as required. Only affects 525 line output.
'b'	625 line if manual standard selected on jumper PL8	525 line if manual standard selected on jumper PL8
'c'	Blank PAL lines 7 to 22 & 320 to 335, NTSC lines 10 to 20 & 273 to 282	Unblank PAL lines 7 to 22 & 320 to 335, NTSC lines 10 to 20 & 273 to 282
'd'	See table below	See table below
'e'	See table below	See table below
'f'	See table below	See table below

GPI test pattern select

Composite output	'd'	'e'	'f'
SDI input	Open	Open	Open
SDI input	Open	Open	Closed
SDI input	Open	Closed	Open
SDI input	Open	Closed	Closed
Pluge	Closed	Open	Open
Vertical edge markers	Closed	Open	Closed
Luma/chroma ramp	Closed	Closed	Open
EBU colour bars	Closed	Closed	Closed

The following tables show the pinout for each frame.

4U frame GPI connections

GPI lines 'a' to 'f' of each card connect to one of eight rear remote connectors as follows:

Slot no.	'a' pin	'b' pin	'c' pin	'd' pin	'e' pin	'f' pin	
Upper	1	8 (1)	9 (1)	18 (1)	26 (1)	19 (2)	20 (2)
	2	7 (1)	16 (1)	17 (1)	25 (1)	10 (2)	11 (2)
	3	8 (3)	9 (3)	18 (3)	26 (3)	19 (4)	20 (4)
	4	7 (3)	16 (3)	17 (3)	25 (3)	10 (4)	11 (4)
	5	5 (1)	6 (1)	15 (1)	24 (1)	1 (2)	2 (2)
	6	4 (1)	14 (1)	13 (1)	23 (1)	3 (2)	4 (2)
	7	5 (3)	6 (3)	15 (3)	24 (3)	1 (4)	2 (4)
	8	4 (3)	14 (3)	13 (3)	23 (3)	3 (4)	4 (4)
	9	3 (1)	12 (1)	22 (1)	21 (1)	12 (2)	13 (2)
	10	10 (1)	11 (1)	19 (1)	20 (1)	21 (2)	22 (2)
	11	3 (3)	12 (3)	22 (3)	21 (3)	12 (4)	13 (4)
	12	10 (3)	11 (3)	19 (3)	20 (3)	21 (4)	22 (4)
Slot no.	'a' pin	'b' pin	'c' pin	'd' pin	'e' pin	'f' pin	
Lower	1	8 (5)	9 (5)	18 (5)	26 (5)	19 (6)	20 (6)
	2	7 (5)	16 (5)	17 (5)	25 (5)	10 (6)	11 (6)
	3	8 (7)	9 (7)	18 (7)	26 (7)	19 (8)	20 (8)
	4	7 (7)	16 (7)	17 (7)	25 (7)	10 (8)	11 (8)
	5	5 (5)	6 (5)	15 (5)	24 (5)	1 (6)	2 (6)
	6	4 (5)	14 (5)	13 (5)	23 (5)	3 (6)	4 (6)
	7	5 (7)	6 (7)	15 (7)	24 (7)	1 (8)	2 (8)
	8	4 (7)	14 (7)	13 (7)	23 (7)	3 (8)	4 (8)
	9	3 (5)	12 (5)	22 (5)	21 (5)	12 (6)	13 (6)
	10	10 (5)	11 (5)	19 (5)	20 (5)	21 (6)	22 (6)
	11	3 (7)	12 (7)	22 (7)	21 (7)	12 (8)	13 (8)
	12	10 (7)	11 (7)	19 (7)	20 (7)	21 (8)	22 (8)

Table shows pin number (Remote number)

Note: Remote 1, Remote 3, Remote 5 and Remote 7 are 26 way high-density D-Type female sockets and frame ground is pin 2 and +5V @500mA is pin 1 in each case.
Remote 2 and Remote 4 are 26 way high-density D-Type male plugs and frame ground is pin 6 and +5V @500mA is pin 15 in each case.

2U frame GPI Connections

GPI lines 'a' to 'f' of each card connect to one of four rear remote connectors as follows:

Slot no.	'a' pin	'b' pin	'c' pin	'd' pin	'e' pin	'f' pin
1	8 (1)	9 (1)	18 (1)	26 (1)	19 (2)	20 (2)
2	7 (1)	16 (1)	17 (1)	25 (1)	10 (2)	11 (2)
3	8 (3)	9 (3)	18 (3)	26 (3)	19 (4)	20 (4)
4	7 (3)	16 (3)	17 (3)	25 (3)	10 (4)	11 (4)
5	5 (1)	6 (1)	15 (1)	24 (1)	1 (2)	2 (2)
6	4 (1)	14 (1)	13 (1)	23 (1)	3 (2)	4 (2)
7	5 (3)	6 (3)	15 (3)	24 (3)	1 (4)	2 (4)
8	4 (3)	14 (3)	13 (3)	23 (3)	3 (4)	4 (4)
9	3 (1)	12 (1)	22 (1)	21 (1)	12 (2)	13 (2)
10	10 (1)	11 (1)	19 (1)	20 (1)	21 (2)	22 (2)
11	3 (3)	12 (3)	22 (3)	21 (3)	12 (4)	13 (4)
12	10 (3)	11 (3)	19 (3)	20 (3)	21 (4)	22 (4)

Table shows pin number (remote number)

Note: Remote 1 and Remote 3 are 26 way high density D-Type female sockets and frame ground is pin 2 and +5V @500mA is pin 1 in each case.
Remote 2 and Remote 4 are 26 way high density D-Type male plugs and frame ground is pin 6 and +5V @500mA is pin 15 in each case.

1U frame GPI connections

GPI lines 'a' to 'f' of each card connect to one of two rear remote connectors as follows:

Slot no.	'a' pin	'b' pin	'c' pin	'd' pin	'e' pin	'f' pin
1	8 (1)	9 (1)	18 (1)	26 (1)	19 (2)	20 (2)
2	7 (1)	16 (1)	17 (1)	25 (1)	10 (2)	11 (2)
3	5 (1)	6 (1)	15 (1)	24 (1)	1 (2)	2 (2)
4	4 (1)	14 (1)	13 (1)	23 (1)	3 (2)	4 (2)
5	3 (1)	12 (1)	22 (1)	21 (1)	12 (2)	13 (2)
6	10 (1)	11 (1)	19 (1)	20 (1)	21 (2)	22 (2)

Table shows pin number (remote number)

Note: Remote 1: 26 way high density D-Type socket. Frame ground is pin 2 and +5V @500mA is pin 1.
Remote 2: 26 way high density D-Type plug. Frame ground is pin 6 and +5V @500mA is pin 15.

DTB-AV GPI connections

GPI lines ‘a’ to ‘f’ of each card connect to the rear remote connector as follows:

Slot no.	‘a’ pin	‘b’ pin	‘c’ pin	‘d’ pin	‘e’ pin	‘f’ pin
1	1	2	3	4	5	6
2	9	10	11	12	13	14

Note: Remote connector is 15 way normal density D-Type socket. Frame ground is pin 15.

Indigo DT desk top box GPI connections

GPI lines ‘a’ to ‘f’ of each card connect to the rear remote connector as follows:

Slot no.	‘a’ pin	‘b’ pin	‘c’ pin	‘d’ pin	‘e’ pin	‘f’ pin
1	8 (1)	9 (1)	18 (1)	26 (1)	19 (2)	20 (2)
2	7 (1)	16 (1)	17 (1)	25 (1)	10 (2)	11 (2)

Table shows pin number (remote number)

Note: Remote 1: 26 way high-density D-Type socket. Frame ground is pin 2 and +5V @500mA is pin 1.
 Remote 2: 26 way high-density D-Type plug. Frame ground is pin 6 and +5V @500mA is pin 15.

2.3 Configuration

Jumper links are provided for the following settings:

- PL8 – manual/AUTO standard selection
- PL 3/4 and PL 5/6 – Y/C or composite selection for certain outputs

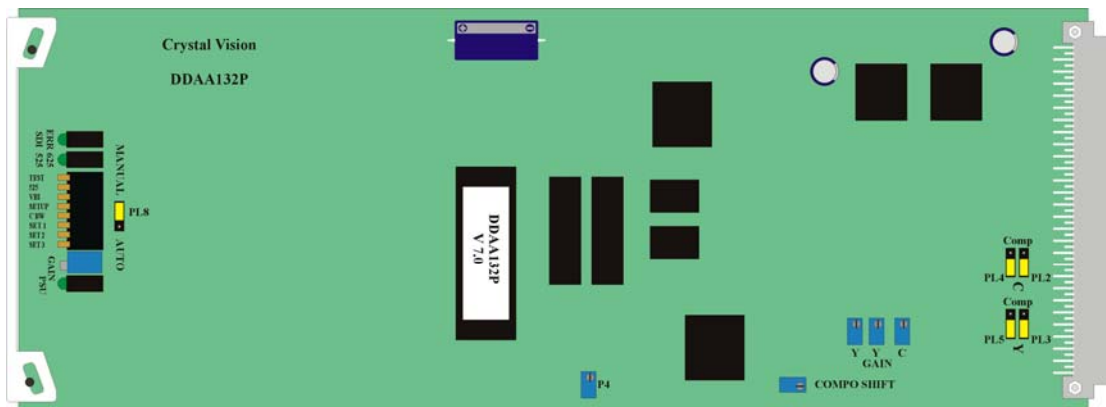

DDAA132P showing configuration jumpers

Changing the standard selection mode

With PL8 in the AUTO position the board will automatically adjust to the 525 or 625 line video standard of the incoming serial digital data.

With PL8 in the MANUAL position the video standard used will be set by the front panel DIL switch or GPI control.

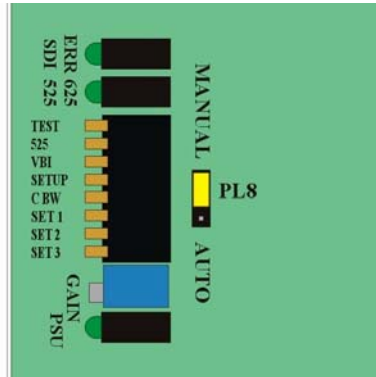

DDAA132P showing configuration jumpers

Note: The AUTO mode may slightly extend the time required to synchronise a new signal.

Changing output signal formats

The following table shows the link position required to select composite or Y/C video for the RM01, RM02, RM18 rear connectors and older frames.

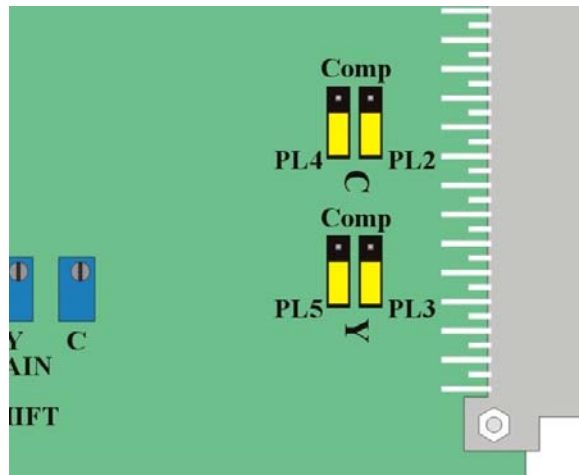

DDAA132P showing configuration jumpers

Link	Link position	Output selected
PL2	PL2 Up (Comp)	Composite
	PL2 Down (C)	C
PL3	PL3 Up (Comp)	Composite
	PL3 Down (Y)	Y
PL4	PL4 Up (Comp)	Composite
	PL4 Down (C)	Y
PL5	PL5 Up (Comp)	Composite
	PL5 Down (Y)	Y

Factory adjustments

The five potentiometers on the board are factory set and should not need re-adjustment.

3 Card edge operation

The front edge of the DDAA132P card provides power rail monitoring, signal status, gain adjustment and configuration switches.

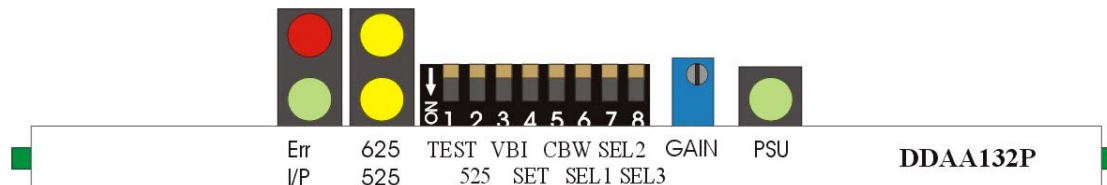

DDAA132P front edge view

The 8 way front edge switch provides access to the following:

- Test – composite output is test pattern or SDI input
- 525 – force standard if board is NOT in AUTO
- VBI – blank or unblank VBI data
- SET – apply 7.5 IRE in NTSC
- CBW – change chroma bandwidth
- SEL1/2/3 – select test pattern

Lever	Up	Down
1	TEST	Composite output is incoming SDI data
2	525	625 line if jumper PL8 in manual position
3	VBI	Blank PAL lines 7 to 22 & 320 to 335, NTSC lines 10 to 20 & 273 to 282
4	SET	No setup
5	CBW	Chroma Bandwidth 1.3MHz
6	SEL1	SDI input active (unless TEST is selected)
7	SEL2	See table below
8	SEL3	See table below

Selecting test patterns

When SEL1 is down, SEL2 and SEL3 select one of four test signals.

Composite output	SEL1	SEL2	SEL3
Pluge	Down	Up	Up
Vertical edge markers	Down	Up	Down
Luma/chroma ramp	Down	Down	Up
EBU colour bars	Down	Down	Down

Notes: The TEST pattern selected with lever 1 overrides SEL1/2/3 patterns. SEL2 and SEL3 have no effect when SEL1 is UP (Default).

LED indicator assignments

LED	Colour	Meaning when lit
INPUT	Green (bottom)	Valid serial digital input detected
ERROR	Red (top)	Serial digital input lock error
625	Yellow (top)	625 line output
525	Yellow (bottom)	525 line output
PSU	Green (top)	Power supply voltage present

Cable equalisation

Cable equalisation is adjusted automatically for up to 200 metres of Belden 8281 or equivalent.

Adjusting input gain

The Y, C and composite gain is continuously variable by $\pm 10\%$ using the GAIN control. The DDAA132P is supplied with a factory set gain of 0dB.

On-board jumper link settings

Please refer to the configuration section to set the following options when using card edge control:

- Changing the standard selection – PL8, AUTO/Manual
- Changing output selection – PL2, 3, 4 and 5

4 Problem solving

The front edge of the card provides useful power rail monitoring in addition to card-edge controls and status LEDs.



DDAA132P front edge view

LED indicator assignments

LED	Colour	Meaning when lit
INPUT	Green (bottom)	Valid serial digital input detected
ERROR	Red (top)	Serial digital input lock error
625	Yellow (top)	625 line output
525	Yellow (bottom)	525 line output
PSU	Green (top)	Power supply voltage present

Basic fault finding guide

The PSU LED is not illuminated

Check that the frame PSU is functioning – refer to the appropriate frame manual for detailed information

Check that the card is seated correctly in the frame

There is no video output

Check that a valid video input is present and that any cabling is intact

Try using the built-in modulated ramp test signal to check output cabling and monitoring

The video output is low quality

Check that the maximum cable length has not been exceeded

Check the card-edge chroma bandwidth setting

I can only see a modulated ramp signal, where's the input video?

Check that the channel's TEST switch is in the UP position to view the input video

The card no longer responds to card edge control

Check that the card is seated correctly and that the PSU LED is lit

If necessary re-set the card

Re-setting the card

If required, the card may be reset by simply removing the rack power and re-applying power after a few seconds or by removing the card from the rack and then re-inserting the card

It is safe to re-insert the card whilst the rack is powered

5 Specification

General

Dimensions	100mm x 266mm module with DIN 41612 connector
Weight	170g
Power consumption	5W

Inputs

Video	270Mb/s serial digital to EBU Tech 3267-E and SMPTE-259M Cable equalisation >200m Belden 8281 or equivalent Auto or manual 525/625 selection
-------	--

Outputs

Number and type:	4 reclocked serial loop through Each will drive >200m Belden 8281 or equivalent 4 analogue outputs, selectable using movable links 2 composite or Y plus syncs, 2 composite or C Composite or Y plus sync are 1V into 75 Ω , C 300mV burst into 75 Ω
------------------	--

Gain adjustment

Continuous adjustment:	$\pm 10\%$ per channel
------------------------	------------------------

Performance

Frequency response:	$\pm 0.2\text{dB}$ 0 to 3.5MHz. $\pm 0.3\text{dB}$ 0 to 5MHz
Blanking:	To PAL/NTSC specification horizontally and vertically with selectable VBI blanking - PAL lines 7-22 & 320-335 and NTSC lines 10-20 & 273-282
Signal to noise ratio:	< -54dB weighted

Test functions

Internal test patterns:	Modulated ramp Vertical edge markers PLUGE Colour bars
-------------------------	---

GPI lines

Inputs: 6 (D-Type on frame)
 NTSC Setup On/Off, Standard select, VBI blank/unblank, Test pattern select

Status monitoring

LED display Front of card edge visual monitoring with LED indicators to indicate:
 PSU rail present
 Input present, I/P error, Standard

Ordering information

DDAA132P	8 bit serial digital to analogue composite converter
Indigo 4	4U frame with passive front panel for up to 24 modules
Indigo 2	2U frame with passive front panel for up to 12 modules
Indigo 1	1U frame with passive front panel for up to 6 modules
Indigo DT	Desk top box with passive front panel for up to 2 modules
Indigo 2A	2U frame, Statesman enabled with active control panel for up to 12 modules
Indigo 1A	1U frame, Statesman enabled with active control panel for up to 6 modules
Indigo DTA	Desk top box, Statesman enabled with active control panel for up to 2 modules
Indigo 4S	4U frame with passive front panel fitted with Statesman CPU for up to 24 modules
Indigo 2S	2U frame with passive front panel fitted with Statesman CPU for up to 12 modules
Indigo 1S	1U frame with passive front panel fitted with Statesman CPU for up to 6 modules
Indigo DTS	Desk top box with passive front panel fitted with Statesman CPU for up to 2 modules
Indigo 2-48V	48V 2U frame with passive front panel for up to 12 modules
Indigo 1-48V	48V 1U frame with passive front panel for up to 6 modules
Indigo 2A-48V	48V 2U frame, Statesman enabled, with active control panel for up to 12 modules
Indigo 1A-48V	48V 1U frame, Statesman enabled, with active control panel for up to 6 modules
Indigo 2S-48V	48V 2U frame with passive front panel fitted with Statesman CPU for up to 12 modules
Indigo 1S-48V	48V 1U frame with passive front panel fitted with Statesman CPU for up to 6 modules
RM01	Single slot rear module with 6 BNCs
RM02	Quad slot rear module with 27 BNCs for 3 boards
RM18	Dual slot rear module for 1 board with 12 BNCs

