

digital keying modular
interface audio
converters analogue video

DEC104S

Composite or Y/C to SDI decoder

USER MANUAL



Contents

1 Introduction	3
Operating modes	4
Output timing	4
Audio follow pulse	4
General Purpose Interface (GPI)	5
2 Statesman	8
2.1 Installing Statesman	8
2.2 Statesman operation	9
Configuration	10
Gain, black level and phase adjustment	12
Timing adjustment	13
3 Using the front control panel	15
The DEC104S menu structure	17
Selecting video standard and decoder modes	18
Setting gain and black level	19
Adjusting signal timing	21
4 Card edge operation	24
Card edge controls	24
Displaying module type and firmware	24
Setting video standard and decoder options	25
Setting gain and black level	26
Adjusting signal timing	27
Setting 525 (NTSC) Setup	30
Restoring factory defaults	30

5 Hardware installation	31
5.1 Rear modules and signal I/O	31
RM01	31
RM23	32
RM24	32
RM25	33
RM27	34
5.2 Module configuration	34
Loop or terminate the composite input	34
Loop or terminate the external reference	35
6 Trouble shooting	36
Card edge monitoring	36
Fault finding guide	36
7 Specification	38

1 Introduction

The DEC104S is an analogue composite or Y/C to serial digital video decoder. It contains a 10 bit synchroniser allowing the serial digital output to be timed to an analogue reference.

Two main operating modes are supported, 10 bit for professional quality PAL or NTSC video and 8 bit for less stable PAL or NTSC video, as is often the case with VHS or satellite feeds.

The decoder is fitted with a 3 line adaptive comb decoder and Crystal Vision's own bandsplit decoder which gives excellent decoding without the artefacts of a comb. This is recommended when using broadcast PAL material. It is also designed to accommodate jittery or damaged signals and will automatically switch to its tolerant 8 bit decoder mode when a non-stable signal is received.

The main features are as follows:

- compact single height module
- converts composite or Y/C signals to SDI
- frame synchroniser
- 10 bit adaptive comb and PAL bandsplit filtering plus 8 bit input modes
- automatic or manual PAL/NTSC standard selection
- adjustable timing, gain and black level
- audio follow pulse for audio to video delay tracking
- GPI outputs for 8 bit lock, ref present, std & audio follow pulse
- loop or terminate external analogue video reference input
- card edge, Statesman and remote control facilities

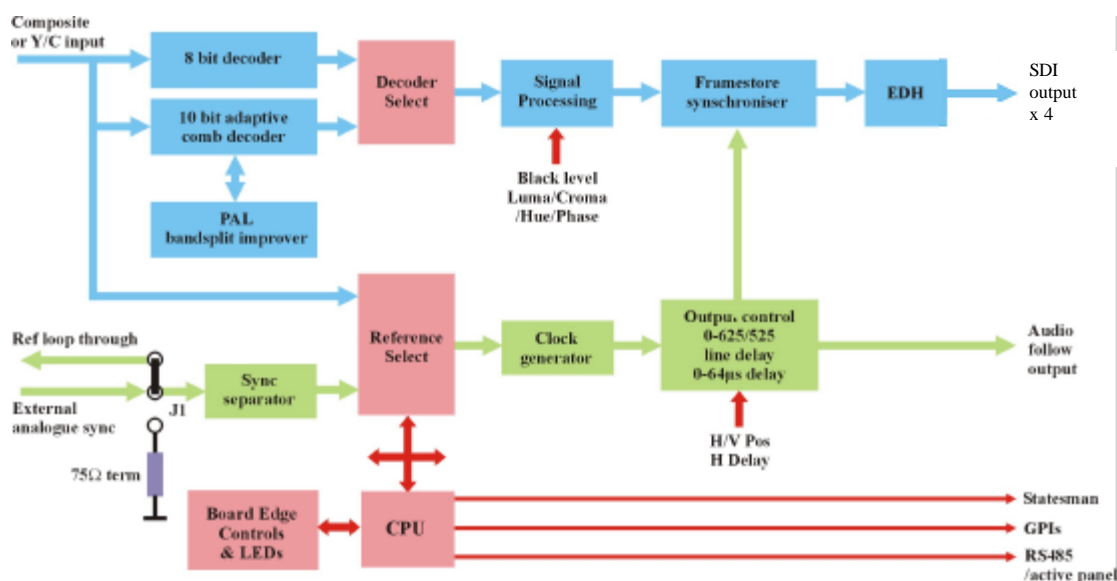

The DEC104S analogue composite or Y/C to serial digital video decoder

The DEC104S is a 100mm x 266mm module, which fits in the all standard frames and can be integrated with any boards from the company's full product range. It uses the single height RM01, RM23, and RM24, double height RM27 and triple height RM25 rear connectors in Indigo and other Crystal Vision frames.

Operating modes

To provide optimum performance with a wide range of sources the DEC104S can operate in a number of different modes.

Input modes	Description
10 bit comb PAL/NTSC composite	Uses a line-based comb decoder, which mixes to simple decoder when the comb would produce artefacts.
10 bit bandsplit PAL composite	High quality analogue bandsplit mode provides best results when PAL material is unsuitable for line-based comb.
10 bit Y/C (S-video)	Suitable for use with well-timed PAL sources.
8 bit composite	All 8 bit modes use a robust simple decoder. These highly tolerant modes are particularly suitable for use with poorly timed sources such as VHS recorders or satellite feeds.
8 bit Y/C (S-video)	

Note: The Y/C input filtering is designed for PAL, use the DEC102S for NTSC Y/C inputs.

Each operating mode has its own luminance and chrominance gain, offset and phase settings and both 525 and 625 line standards have separate horizontal and vertical timing settings. All these parameters are automatically maintained when power is cycled.

Output timing

Horizontal and vertical timing adjustments are provided that operate relative to one of three analogue timing references. These are an external reference, the video input or an internal free-running clock. The external reference can be video or composite syncs although a composite black and burst plus 300mV syncs into 75 Ohm as per EBU N14-1988 is preferred.

If no analogue reference is provided the board will either time itself relative to the composite or Y/C video input in 10 bit modes, or it will time its output to a free running clock in 8 bit modes.

A horizontal offset delay adjustment varies the timing of the input video relative to input syncs and blanking in 10 bit mode whichever source is the active reference.

Audio follow pulse

To allow an audio delay to track the video delay through the DEC104S, a TTL level pulse is provided. This audio follow pulse is available from GPI5 and the RM27 rear module. This pulse is output every frame. The length of the pulse (the time between the rising and falling edge) is the same as the delay through the synchroniser.

General Purpose Interface (GPI)

The DEC104S, as with most Crystal Vision modules, is equipped with GPI control I/O.

GPI		Low (<1V)	High (+5V)
0	'a' No connect		
1	'b' 8 bit lock	Lose of 8 bit lock	8 bit locked
2	'c' No connect		
3	'd' Reference present	No reference present	Reference present
4	'e' Input standard	625	525
5	'f' Audio follow pulse	Pulse width equal to audio delay	

As supplied, each GPI output has a 330ohm resistor in series with its output. This allows for an external LED to be driven, connected to a dc voltage of +5V.

4U frame GPI Connections

GPI lines 'a' to 'f' of each card connect to one of eight rear remote connectors as follows:

Slot no.	'a' pin	'b' pin	'c' pin	'd' pin	'e' pin	'f' pin
1	8 (1)	9 (1)	18 (1)	26 (1)	19 (2)	20 (2)
2	7 (1)	16 (1)	17 (1)	25 (1)	10 (2)	11 (2)
3	8 (3)	9 (3)	18 (3)	26 (3)	19 (4)	20 (4)
4	7 (3)	16 (3)	17 (3)	25 (3)	10 (4)	11 (4)
5	5 (1)	6 (1)	15 (1)	24 (1)	1 (2)	2 (2)
6	4 (1)	14 (1)	13 (1)	23 (1)	3 (2)	4 (2)
7	5 (3)	6 (3)	15 (3)	24 (3)	1 (4)	2 (4)
8	4 (3)	14 (3)	13 (3)	23 (3)	3 (4)	4 (4)
9	3 (1)	12 (1)	22 (1)	21 (1)	12 (2)	13 (2)
10	10 (1)	11 (1)	19 (1)	20 (1)	21 (2)	22 (2)
11	3 (3)	12 (3)	22 (3)	21 (3)	12 (4)	13 (4)
12	10 (3)	11 (3)	19 (3)	20 (3)	21 (4)	22 (4)
Slot no.	'a' pin	'b' pin	'c' pin	'd' pin	'e' pin	'f' pin
1	8 (5)	9 (5)	18 (5)	26 (5)	19 (6)	20 (6)
2	7 (5)	16 (5)	17 (5)	25 (5)	10 (6)	11 (6)
3	8 (7)	9 (7)	18 (7)	26 (7)	19 (8)	20 (8)
4	7 (7)	16 (7)	17 (7)	25 (7)	10 (8)	11 (8)
5	5 (5)	6 (5)	15 (5)	24 (5)	1 (6)	2 (6)
6	4 (5)	14 (5)	13 (5)	23 (5)	3 (6)	4 (6)
7	5 (7)	6 (7)	15 (7)	24 (7)	1 (8)	2 (8)
8	4 (7)	14 (7)	13 (7)	23 (7)	3 (8)	4 (8)
9	3 (5)	12 (5)	22 (5)	21 (5)	12 (6)	13 (6)
10	10 (5)	11 (5)	19 (5)	20 (5)	21 (6)	22 (6)
11	3 (7)	12 (7)	22 (7)	21 (7)	12 (8)	13 (8)
12	10 (7)	11 (7)	19 (7)	20 (7)	21 (8)	22 (8)

Table shows pin number (Remote number)

Note: Remote 1, Remote 3, Remote 5 and Remote 7 are 26 way high density D-Type female sockets and frame ground is pin 2 and +5V @500mA is pin 1 in each case.
Remote 2 and Remote 4 are 26 way high density D-Type male plugs and frame ground is pin 6 and +5V @500mA is pin 15 in each case.

2U frame GPI Connections

GPI lines 'a' to 'f' of each card connect to one of four rear remote connectors as follows:

Slot no.	'a' pin	'b' pin	'c' pin	'd' pin	'e' pin	'f' pin
1	8 (1)	9 (1)	18 (1)	26 (1)	19 (2)	20 (2)
2	7 (1)	16 (1)	17 (1)	25 (1)	10 (2)	11 (2)
3	8 (3)	9 (3)	18 (3)	26 (3)	19 (4)	20 (4)
4	7 (3)	16 (3)	17 (3)	25 (3)	10 (4)	11 (4)
5	5 (1)	6 (1)	15 (1)	24 (1)	1 (2)	2 (2)
6	4 (1)	14 (1)	13 (1)	23 (1)	3 (2)	4 (2)
7	5 (3)	6 (3)	15 (3)	24 (3)	1 (4)	2 (4)
8	4 (3)	14 (3)	13 (3)	23 (3)	3 (4)	4 (4)
9	3 (1)	12 (1)	22 (1)	21 (1)	12 (2)	13 (2)
10	10 (1)	11 (1)	19 (1)	20 (1)	21 (2)	22 (2)
11	3 (3)	12 (3)	22 (3)	21 (3)	12 (4)	13 (4)
12	10 (3)	11 (3)	19 (3)	20 (3)	21 (4)	22 (4)

Table shows pin number (Remote number)

Note: Remote 1 and Remote 3 are 26 way high density D-Type female sockets and frame ground is pin 2 and +5V @500mA is pin 1 in each case.
Remote 2 and Remote 4 are 26 way high density D-Type male plugs and frame ground is pin 6 and +5V @500mA is pin 15 in each case.

1U frame GPI connections

GPI lines 'a' to 'f' of each card connect to one of two rear remote connectors as follows:

Slot no.	'a' pin	'b' pin	'c' pin	'd' pin	'e' pin	'f' pin
1	8 (1)	9 (1)	18 (1)	26 (1)	19 (2)	20 (2)
2	7 (1)	16 (1)	17 (1)	25 (1)	10 (2)	11 (2)
3	5 (1)	6 (1)	15 (1)	24 (1)	1 (2)	2 (2)
4	4 (1)	14 (1)	13 (1)	23 (1)	3 (2)	4 (2)
5	3 (1)	12 (1)	22 (1)	21 (1)	12 (2)	13 (2)
6	10 (1)	11 (1)	19 (1)	20 (1)	21 (2)	22 (2)

Table shows pin number (Remote number)

Note: Remote 1: 26 way high density D-Type socket. Frame ground is pin 2 and +5V @500mA is pin 1.
Remote 2: 26 way high density D-Type plug. Frame ground is pin 6 and +5V @500mA is pin 15.

DTB-AV Desk Top Box GPI connections

GPI lines 'a' to 'f' of each card connect to the rear remote connector as follows:

Slot no.	'a' pin	'b' pin	'c' pin	'd' pin	'e' pin	'f' pin
1	1	2	3	4	5	6
2	9	10	11	12	13	14

Note: Remote connector is 15 way normal density D-Type socket. Frame ground is pin 15.

Indigo DT Desk Top Box GPI connections

GPI lines 'a' to 'f' of each card connect to the rear remote connector as follows:

Slot no.	'a' pin	'b' pin	'c' pin	'd' pin	'e' pin	'f' pin
1	8 (1)	9 (1)	18 (1)	26 (1)	19 (2)	20 (2)
2	7 (1)	16 (1)	17 (1)	25 (1)	10 (2)	11 (2)

Table shows pin number (Remote number)

Note: Remote 1: 26 way high density D-Type socket. Frame ground is pin 2 and +5V @500mA is pin 1.
Remote 2: 26 way high density D-Type plug. Frame ground is pin 6 and +5V @500mA is pin 15.

2 Statesman

The Crystal Vision Statesman PC control software is designed to control a range of Crystal Vision modules via serial control from a PC.

The main Statesman application communicates with each module in a frame through an active control panel with or without an LCD display. Statesman will not normally be able to detect modules used in a frame with only a passive front panel.

2.1 Installing Statesman

Minimum pre-requisites:

- A PC running Windows 98, NT4 with SP 5 or higher Windows 2000 or Windows XP
- A parallel port dongle supplied with the Statesman software package
- An RS422 serial connection from the host PC to the Indigo frame control input or to Remote 2 connector on an FR1AV or FR2AV Crystal Vision frame with at least one DEC104S module and/or other Statesman compatible module
- An active control panel **MUST** be fitted to the frame with version 1.63 or above firmware – if it is an Indigo frame the firmware must be V1.04 or above
- An optional RS422 to RS232 converter if the PC has no RS422 ports

Installing Statesman

- Refer to the readme and/or help file on the CD before proceeding
- To view all application windows, set graphics resolution to at least 1024 x 768
- Remove any previous version of the Statesman software using the Add/Remove Programs application in the Windows Control Panel
- Ensure that the Statesman dongle is fitted to the parallel port of the host PC
- Insert the Statesman CD and the installation should start immediately – if it does not, run the setup.exe file on the CD
- Obey any installation program prompts and restart the PC when prompted

Running Statesman for the first time

The Statesman PC Control System may be run from the Crystal Vision programs folder via the Start menu or by double-clicking on the Crystal Vision.exe file in the installed program directory.

When the program runs it will require licence information and an administrator name and password. It will also need to know which computer port is being used to connect to a Crystal Vision frame(s).

Note: For further details of Statesman configuration please refer to the Statesman manual.

2.2 Statesman operation

Once Statesman is configured it should automatically detect any Statesman compatible modules in the connected frame or frames and display them in the main application left hand explorer-style window.

Open any frame by clicking on the + sign or by double clicking on a frame. Installed modules should be shown with module icons. Frame and module icons can be named as desired by right-clicking or using the edit menu and choosing rename.

To aid user recognition of module and frame status quickly, the following colour and size coding is used:

- A module is shown present by full colour and absent by greyed colour
- A module is shown open by large icon size and closed by small icon
- A module is the source of an active alarm if red and not alarmed if green

Double-clicking on a module will enable the display of the main application menus.

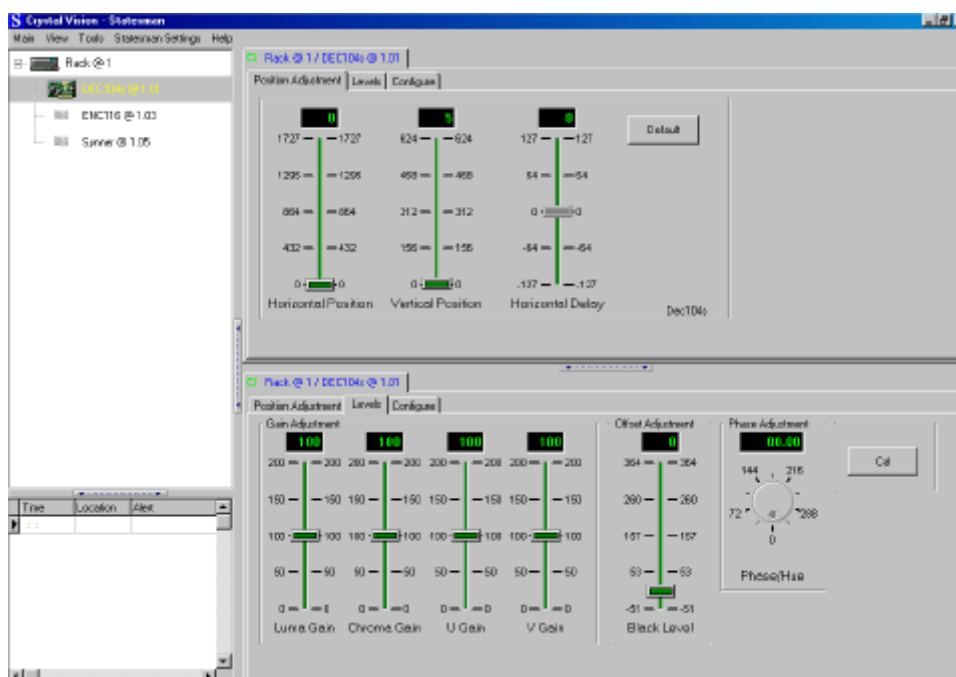

Statesman main application window

The two large control panes shown in the upper and lower halves of the window may display different menus for the same card, or controls for different cards. Click on the horizontal button-bar between the two panes to close the lower plane or drag the button to vary the size of the panes.

Note: For further details of Statesman configuration and operation please refer to the Statesman manual.

Configuration

The configuration tab provides access to the following:

- PAL/NTSC/Auto - standard selection
- YC/Composite – format selection
- 8 bit/10 bit – simple or comb/bandsplit filter decoding
- Comb/bandsplit – use bandsplit if input unsuitable for comb filter
- Blank or unblank the VBI interval
- Pedestal – pass or block the NTSC pedestal
- Status – input and reference presence

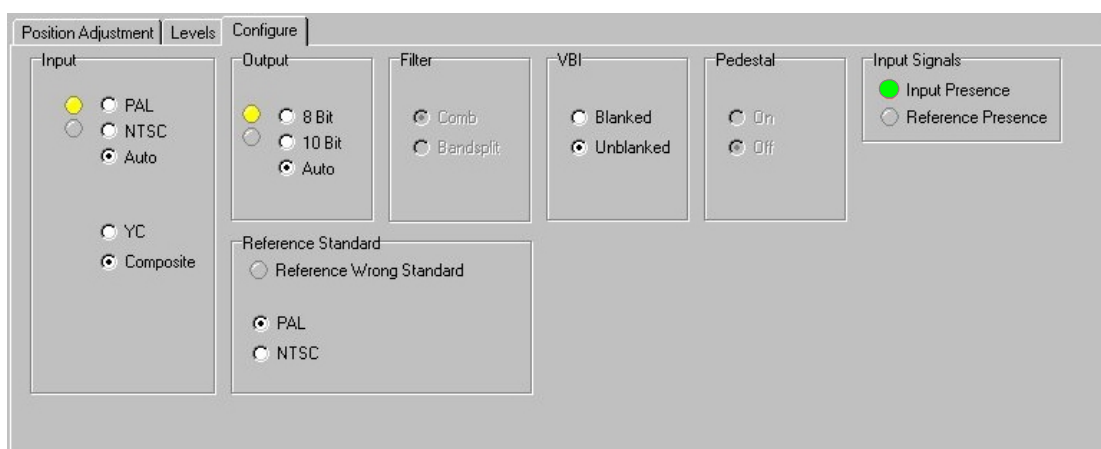

Configuration

Input settings

Input settings are as follows:

Input setting	Description
PAL/NTSC/Auto	Force input standard or allow automatic switching between PAL and NTSC
YC /Composite	Select Y/C (S-Video) or composite input format

Note: When the input is NTSC the Y/C mode automatically sets the module into 8 bit mode. Use the DEC102 for 10 bit mode with NTSC inputs in Y/C format.

Output settings

Output settings are as follows:

Output setting	Description
8 bit/10 bit/Auto	Force 10 or 8 bit output quality or allow automatic selection. When the input is NTSC the Y/C mode automatically sets the module into 8 bit mode
Comb/bandsplit	Select decoder quality setting – 10 bit adaptive comb decoder mode or 10 bit HIGH QUALITY bandsplit mode
VBI Blanked /Unblanked	VBI data blocked or passed unprocessed (unblanked) on luminance channel
Pedestal (NTSC only)	ON: 7.5 IRE subtracted from black level, gain increased OFF: Black level and gain settings assume no 7.5 IRE offset

Note: Vertical Blanking Interval data is normally present in PAL on lines 7-22 and 319-335 and in NTSC on lines 10-20 and 273-282.

Status

Status indications are as follows:

Input setting	Description
Input presence	Green when input detected. Grey when no input detected.
Reference present	Yellow when analogue reference detected. Grey when no input detected.

Note: Refer to the installation section for details of the external analogue reference input loop or terminate link on the module itself.

Gain, black level and phase adjustment

The level adjustment tab provides access to the following:

- Luma and Chroma gain
- U and V gain
- Black level
- Phase/Hue – 10 bit mode only

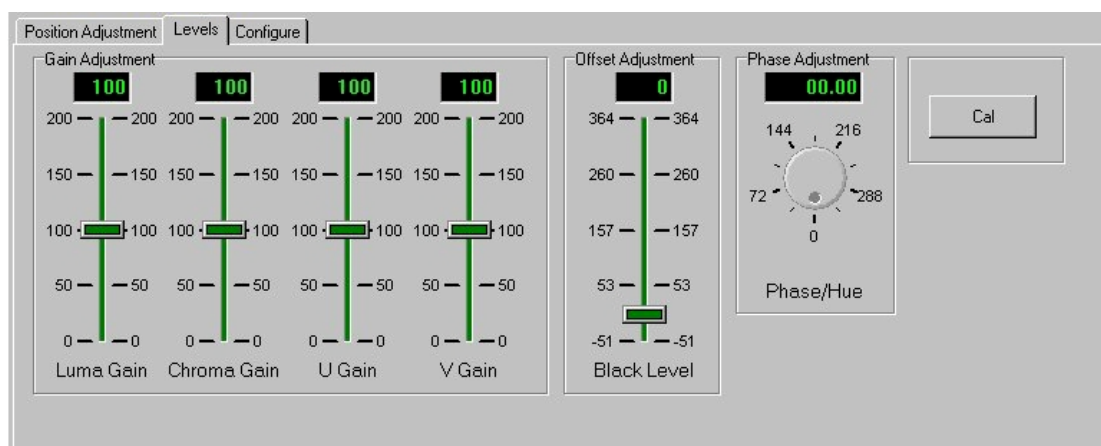

Level adjustment controls

Setting gain and black level

The gain and black level adjustments are independent for 8 and 10 bit modes as well as comb, bandsplit and Y/C modes. For example, if the unit is set up in 10 bit mode and subsequently adjusted in 8 bit mode, the 10 bit adjustments are maintained and will be restored when 10 bit operation is resumed.

There are effectively five sets of independent gain and offset adjustments; 8 bit composite, 10 bit comb, 10 bit bandsplit, 8 bit Y/C and 10 bit Y/C.

Adjusting phase/hue

The phase adjustment is separate for each video standard and for composite and Y/C inputs. This adjustment is available in 10 bit mode only.

The Phase/Hue control adjusts chroma phase relative to burst. The range of adjustment is 360 degrees, in steps of roughly 0.1degrees. When the maximum adjustment is reached the value wraps around to zero.

Recalling defaults

To recall default settings press the Cal button.

Timing adjustment

The position adjustment tab provides access to the following:

- Horizontal position - output timing in 37ns steps
- Vertical position - output timing in one line steps
- Horizontal delay - input timing in 37ns steps (10 bit mode only)

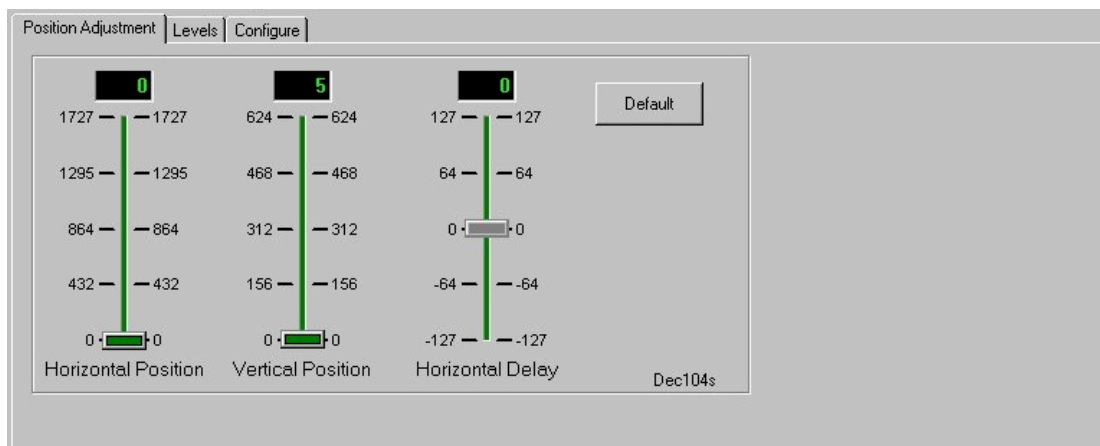

Position adjustment controls

Different horizontal and vertical timing adjustments can be maintained for 625 and 525 line operation. However, the horizontal delay is common to both 525 and 625

Note: The horizontal delay and phase controls are not available in 8 bit mode.

The active output timing reference

The horizontal and vertical timing adjustments operate relative to one of three analogue timing references. These are an external reference, the composite or Y/C input or an internal free-running clock. Which of these is the active reference is dependent on the presence of an external reference or whether an 8 bit or 10 bit mode is in operation.

When an external analogue timing reference is present serial output timing is maintained relative to the external analogue reference.

When no external analogue timing reference is present the serial output timing depends on whether the decoder is in 10 or 8 bit mode. In 10 bit mode the serial output is timed to the composite or Y/C input. In 8 bit mode the output is timed to a free running factory set clock. The following tables summarises the possible output timing reference sources:

Active timing reference	Ext Ref	Mode
External analogue input	Present	10 or 8 bit
Composite or Y/C input	Not present	10 bit
Free running internal clock	Not present	8 bit

Adjusting horizontal and vertical timing

The horizontal position slider adjusts output timing relative to the active analogue reference in steps of 37ns. The range of adjustment is one video line.

The vertical position slider adjusts the output timing relative to the active analogue reference in steps of one video line. The range of adjustment is one video frame. When the maximum adjustment is reached the slider will move to zero.

Note: Attempts to exceed 524 on the vertical slider graticule in NTSC mode will reset the slider to zero.

When both horizontal and vertical position settings are zero the serial output will be timed to the analogue reference as per ITU-R BT.601. Increasing the vertical position setting will delay the output relative to the reference in increments of one video line. Increasing the Horizontal position setting will increase this delay in increments of 37ns.

With an analogue timing reference present the delay through the board depends on this adjustment and the relative timing of the serial input and the analogue reference.

When both vertical position and horizontal position are set to zero the delay through the board will be at a minimum. The minimum delay through the board is approximately 1.7 lines in 10 bit mode and 0.7 lines in 8 bit mode.

Adjusting input video timing

The horizontal delay adjustment varies the timing of the input video relative to input syncs and blanking in 10 bit mode whichever source is the active reference.

Mode	Input video timing
10 bit	Relative to input video syncs and blanking
8 bit	No horizontal delay available

The horizontal delay slider adjusts the input video timing with respect to the input video syncs in steps of 37ns. This adjustment is available in 10 bit mode only. The available range is -128 to +127 steps (roughly +/- 4.5 microseconds) relative to the factory default position. The value cannot be adjusted outside this range.

Recalling defaults

To recall default settings press the Default button.

3 Using the front control panel

This operational guide assumes that the panel has been setup according to the Panel setup procedure described in the Crystal Vision Control Panel manual.

Note: It is **ESSENTIAL** that the Panel setup procedure is followed and any old or unknown passwords cleared prior to using the panel for the first time.

At power up, the two line 20-character screen will display 'Crystal Vision' followed by the firmware version number for the control panel. All eight control panel key LEDs will illuminate.



The Crystal Vision control panel start up display

'Control Panel' then briefly replaces the version number display.



If the control panel firmware has been updated for Statesman control (version 1.5.0 or higher), Statesman Mode will be entered and the message, 'Press CAL to Exit' will be displayed and the CAL LED will light.



Statesman mode is entered by default

To continue with control panel operation or configuration, press the CAL key once. A second press of the CAL key will return to Statesman control.

The control panel will display the name of the card that first responds to the polling request together with its location number.

The location number consists of the frame number plus the card position in the frame.

Navigating the display

The functions assigned to control panel keys are:

- **DEVICE** – enters Device menu to select a card or show cards available / enter Panel setup when held down during power up / shows frame status when pressed from Statesman mode
- **CAL** – Enter or leave Statesman mode / enter panel diagnostics mode when held down during power up / updates the display
- **Asterisk** – enters board rename menu from the Device menu
- **F1 to F4** – soft keys, function assigned within each menu
- **HOME** – moves the display to the home menu
- **ENTER** – accept current selection
- **Upward arrow** – used to move up the menu structure / enter lock panel menu from the Device menu
- **Rotary control** – shaft encoder used to select options or variable data

Menu numbering scheme

This manual uses a simple menu numbering convention based on the sequence of keys required to reach each menu from the top level home menu. For example, menu 1.1.2 is reached from the home menu by pressing F1, then F2. Menu 1.2.3 is reached by pressing F2 and then F3.

Note: Please refer to the Crystal Vision Control Panel manual for details of the Panel Setup, Lock Panel and Diagnostic menus.

Selecting the DEC104S

To select a particular card in a frame, press the **DEVICE** key to go to the Device menu. The top line of the display will show 'Available Cards X', where X is the number of cards that have responded so far to the polling request.



The available cards menu

Rotate the shaft encoder and the bottom row will display the successfully polled cards by name and location or slot number

In the example above, the card displayed is located in the first frame in slot number 1.

When the desired card is selected press the **ENTER** key to access that card's **HOME** menu.

If remote control has been enabled, the control panel will then enter card mode and communicate with the DEC104S at the node number last displayed in the available cards list.



The DEC104S home menu

Updating the display

The values displayed on an active front panel are only updated when an adjustment is made and when changing menu level. If mode changes occur through the use of Statesman, card edge controls or through automatic response to the input video signal, the text displayed on the active front panel will not be updated immediately. If necessary, press CAL to update the display.

The DEC104S menu structure

The main top-level menus are obtained by pressing the F1, F2 and F4 keys from the HOME menu. Menu keys are illuminated when active and when further menus are available. The three top-level menus are:

CONF (Configuration) – press F1

LEVEL (Level adjustment) – press F2

TIME (Input/output timing and phase) – press F4

The following chart shows the available DEC104S menus. The actual menus available may vary slightly as software is updated.

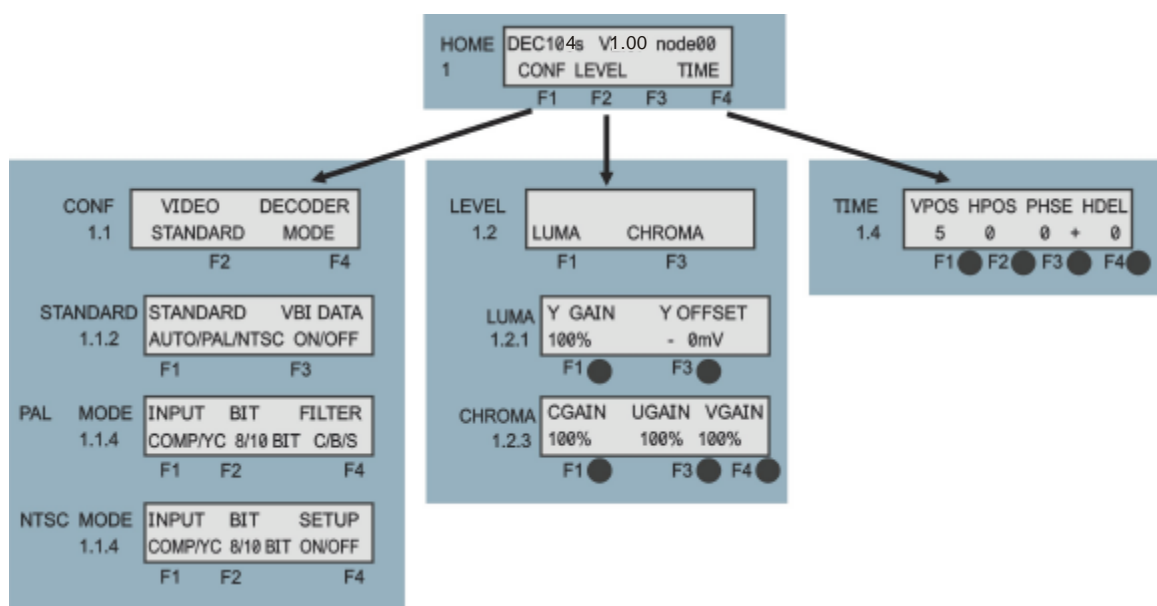

The DEC104S menu tree

Note: Function keys and shaft encoder LEDs are illuminated when active. Menus or function keys associated with the shaft encoder for changing assigned values are shown with a black circle.

Selecting video standard and decoder modes

Press F1 from the home menu to display the configuration menu with the following options:

- Video standard selection
- VBI pass/blank select
- Decoder mode selection
- Setup on/off in NTSC

Configuration menu structure	Description									
CONF 1.1 <table border="1" style="margin-left: 20px;"> <tr> <td>VIDEO STANDARD</td> <td>DECODER MODE</td> </tr> <tr> <td style="text-align: center;">F2</td> <td style="text-align: center;">F4</td> </tr> </table>	VIDEO STANDARD	DECODER MODE	F2	F4	Use F2 to select Video Standard menu and F4 to select Mode menu					
VIDEO STANDARD	DECODER MODE									
F2	F4									
STANDARD 1.1.2 <table border="1" style="margin-left: 20px;"> <tr> <td>STANDARD</td> <td>VBI DATA</td> </tr> <tr> <td>AUTO/PAL/NTSC</td> <td>ON/OFF</td> </tr> <tr> <td style="text-align: center;">F1</td> <td style="text-align: center;">F3</td> </tr> </table>	STANDARD	VBI DATA	AUTO/PAL/NTSC	ON/OFF	F1	F3	Video Standard F1 selects PAL, NTSC or AUTO F3 selects VBI data ON or OFF			
STANDARD	VBI DATA									
AUTO/PAL/NTSC	ON/OFF									
F1	F3									
PAL MODE 1.1.4 <table border="1" style="margin-left: 20px;"> <tr> <td>INPUT</td> <td>BIT</td> <td>FILTER</td> </tr> <tr> <td>COMP/YC</td> <td>8/10 BIT</td> <td>C/B/S</td> </tr> <tr> <td style="text-align: center;">F1</td> <td style="text-align: center;">F2</td> <td style="text-align: center;">F4</td> </tr> </table>	INPUT	BIT	FILTER	COMP/YC	8/10 BIT	C/B/S	F1	F2	F4	Decoder Mode (PAL) F1 selects COMP (Composite) or Y/C F2 selects 8 bit, 10 bit or Auto F4 selects comb or bandsplit in COMP 10 bit mode Filter is comb in Y/C mode and Simple in 8 bit mode
INPUT	BIT	FILTER								
COMP/YC	8/10 BIT	C/B/S								
F1	F2	F4								
NTSC MODE 1.1.4 <table border="1" style="margin-left: 20px;"> <tr> <td>INPUT</td> <td>BIT</td> <td>SETUP</td> </tr> <tr> <td>COMP/YC</td> <td>8/10 BIT</td> <td>ON/OFF</td> </tr> <tr> <td style="text-align: center;">F1</td> <td style="text-align: center;">F2</td> <td style="text-align: center;">F4</td> </tr> </table>	INPUT	BIT	SETUP	COMP/YC	8/10 BIT	ON/OFF	F1	F2	F4	Decoder Mode (NTSC) F1 selects COMP (Composite) or Y/C F2 selects 8 bit, 10 bit or Auto F4 selects SETUP ON/OFF 10 bit mode is not available in NTSC when Y/C is selected.
INPUT	BIT	SETUP								
COMP/YC	8/10 BIT	ON/OFF								
F1	F2	F4								

Video standard

Press F1 to switch the video standard through AUTO, PAL and NTSC in turn. In AUTO mode, the board will switch automatically to the correct video standard based on the input signal.

If VBI (Vertical Blanking Interval) data is set to ON, the data is passed as undecoded luminance. In PAL this affects lines 7 to 22 and 319 to 335, in NTSC it affects lines 10 to 20 and 273 to 282.

Decoder mode

Press F1 to switch the input between COMP for a composite input signal and Y/C for an S-Video input signal.

Press F2 to switch through AUTO, 8 bit and 10 bit. AUTO allows the board to switch to the appropriate bit mode based on the input signal timing stability. In PAL the Filter text above F4, will be updated automatically as the board switches between bit modes.

When the board is set for PAL, composite input with 10 bit decoding, F4 can be used to toggle between adaptive comb decoding or BNDSPILT for high quality bandsplit decoding.

Simple decoding is automatically selected for 8 bit mode and comb is automatically selected for 10 bit Y/C mode.

In NTSC, F4 is used to toggle SETUP ON or OFF.

Note: 10 bit mode is not available in NTSC when Y/C is selected. Use the DEC102S for 10 bit mode with NTSC inputs in Y/C format.

Setting gain and black level

Press F2 from the home menu to display the top Level menu providing the following functions:

Luminance gain and offset (black level)

Chrominance gain

The gain and black level adjustments are independent for 8 and 10 bit modes as well as comb, bandsplit and Y/C modes. For example, if the unit is set up in 10 bit mode and subsequently adjusted in 8 bit mode, the 10 bit adjustments are maintained and will be restored when 10 bit operation is resumed.

There are effectively five sets of independent gain and offset adjustments; 8 bit composite, 10 bit comb, 10 bit bandsplit, 8 bit Y/C and 10 bit Y/C.

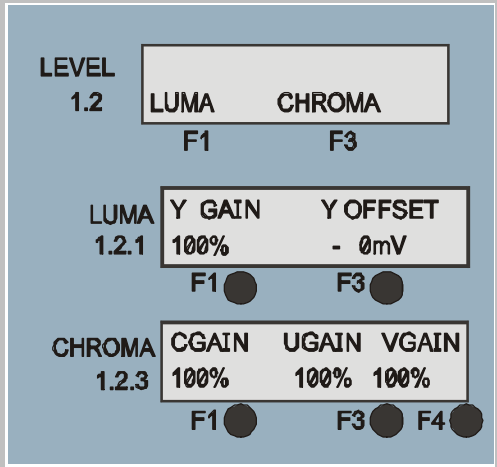
Level menu structure	Description
 <p>The diagram shows the menu structure on the front panel. At level 1.2, there are two options: LUMA (selected by F1) and CHROMA (selected by F3). At level 1.2.1 (LUMA), there are two options: Y GAIN (selected by F1) and Y OFFSET (selected by F3). At level 1.2.3 (CHROMA), there are three options: CGAIN (selected by F1), UGAIN (selected by F3), and VGAIN (selected by F4). The CAL button is used to reset all gains to their default values.</p>	<p>Use F1 to select Luminance menu and F3 to select Chrominance menu</p> <p>F1 allows ADJ shaft encoder to set luminance gain F3 allows ADJ shaft encoder to set black level CAL sets gain and black level to unity values</p> <p>F1 allows ADJ shaft encoder to set overall chroma gain F3 allows ADJ shaft encoder to set U chroma gain F4 allows ADJ shaft encoder to set V chroma gain CAL sets all chroma gains to unity values</p>

Note: The displayed number varies as the shaft encoder is rotated to give an indication of the setting relative to the factory default

Setting luminance gain and black level

Select the LUMA menu to allow the luminance gain and offset (black level) for the current mode to be adjusted.

Press the F1 button to allow the shaft encoder to adjust the luminance gain. The shaft encoder LED will illuminate and an asterisk will appear on the display next to 'Y GAIN'. Use the shaft encoder to adjust the luminance gain from 0 to 200%.

Press the F3 button to allow the shaft encoder to adjust the black level. The shaft encoder LED will illuminate and an asterisk will appear on the display next to 'Y OFFSET'. Use the shaft encoder to adjust the black level from -30 to +385mV.

Press the CAL button at any time while in this menu to set gain and offset to their default values (100% and 0mV).

Setting chrominance gains

Select the CHROMA menu to allow the chrominance gains for the current mode to be adjusted.

Press the F1 button to allow the shaft encoder to adjust the combined chrominance gain from 0 to 200%. The shaft encoder LED will illuminate and an asterisk will appear on the display next to 'CGAIN'. The shaft encoder will adjust both the U and V gains by the same proportion of their default values. The CGAIN value is an average of the U and V values.

Press the F3 button to allow the shaft encoder to adjust the U gain from 0 to 200%. The shaft encoder LED will illuminate and an asterisk will appear on the display next to UGAIN.

Press the F4 button to allow the shaft encoder to adjust the V gain from 0 to 200%. The shaft encoder LED will illuminate and an asterisk will appear on the display next to 'VGAIN'.

Press the CAL button at any time while in this menu to set all gains to their default values (100%).

Adjusting signal timing

Press F4 from the home menu to display the Timing menu, which provides the following timing functions:

Output timing relative to the external reference

Chroma phase relative to burst (10 bit mode only)

Input video timing (10 bit mode only)

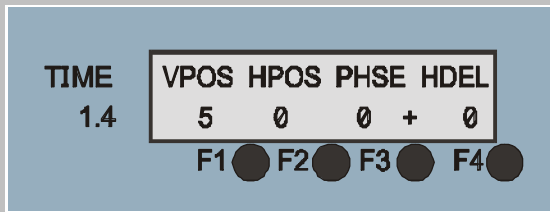
Timing menu structure	Description
	<p>Use the F buttons below each function to enable the ADJ shaft encoder to change values.</p> <p>F1: ADJ sets VPOS (output timing in one line steps) F2: ADJ sets HPOS (output timing in 37ns steps) F3: ADJ sets PHSE (chroma timing in 0.1° steps) F4: ADJ sets HDEL (input timing in 37ns steps)</p>

Different horizontal and vertical timing adjustments can be maintained for 625 and 525 line operation. However, the horizontal delay is common to both 525 and 625. Settings are automatically maintained when the unit is powered off and restored when the unit is powered back on.

Note: The horizontal delay (HDEL) and phase control (PHSE) are not available in 8 bit mode.

The active output timing reference

The horizontal and vertical timing adjustments operate relative to one of three analogue timing references. These are an external reference, the composite or YC input or an internal free-running clock. Which of these is the active reference is dependent on the presence of an external reference or whether an 8 bit or 10 bit mode is in operation.

When an external analogue timing reference is present serial output timing is maintained relative to the external analogue reference.

When no external analogue timing reference present the serial output timing depends on whether the decoder is in 10 or 8 bit mode. In 10 bit mode the serial output is timed to the composite or Y/C input. In 8 bit mode the output is timed to a free running clock.

The following tables summarises the possible output timing reference sources:

Active timing reference	Ext Ref	Mode
External analogue input	Present	10 or 8 bit
Composite or Y/C input	Not present	10 bit
Free running internal clock	Not present	8 bit

Adjusting horizontal and vertical timing

Increasing the vertical position setting will delay the output relative to the reference in increments of one video line. Press the F1 button to allow the shaft encoder to adjust the vertical output timing. The shaft encoder LED will illuminate and an asterisk will appear on the display next to 'VPOS'. The range of adjustment is one video frame. When the maximum adjustment is reached the value wraps around to zero.

Increasing the horizontal position setting will delay the output relative to the reference in increments of 37ns. Press the F2 button to allow the shaft encoder to adjust the horizontal output timing. The shaft encoder LED will illuminate and an asterisk will appear on the display next to 'HPOS'. The range of adjustment is one video line.

With an external analogue timing reference present the delay through the board depends on these adjustments and the relative timing of the serial input and the analogue reference. When both horizontal and vertical position settings are zero the delay thorough the board will be minimum and the serial output will be timed to the analogue reference as per ITU-R BT.601. The minimum delay through the board is approximately 1.7 lines in 10 bit mode and 0.7 lines in 8 bit mode.

Adjusting chroma phase

Press the F3 button to the shaft encoder to adjust the chroma phase relative to burst. This adjustment is available in 10 bit mode only. The shaft encoder LED will illuminate and an asterisk will appear on the display next to 'PHSE'. The range of adjustment is 360 degrees, in steps of roughly 0.1degrees. When the maximum adjustment is reached the value wraps around to zero.

Adjusting input video timing

The horizontal delay adjustment varies the timing of the input video relative to input syncs and blanking in 10 bit mode whichever source is the active reference.

Mode	Input video timing
10 bit	Relative to input video syncs and blanking
8 bit	No horizontal delay available

Press the F4 button to allow the shaft encoder to adjust the input video timing with respect to the input video syncs in steps of 37ns. This adjustment is available in 10 bit mode only. The shaft encoder LED will illuminate and an asterisk will appear on the display next to 'HDEL'. The available range is -128 to +127 steps (roughly +/- 4.5 microseconds) relative to the factory default position. The value cannot be adjusted outside this range.

Recalling defaults

There is no CAL function for the timing adjustments. See also 'Restoring factory defaults' in the Card-edge operation section.

4 Card edge operation

The control of the DEC104S will always follow the last control surface used. For example, if a card edge lever is moved the unit will switch to and remain in the Local Control Mode. If Statesman or any control panel menu is used, then the unit will switch to and remain in the Remote Control Mode. The settings made will be remembered after a power down and the last control mode used will be retained.

Piano switch and jumper settings are only read when they are changed. However, the board will configure itself according to local configuration changes even if the changes occurred while the board had been powered down.

The auto-configuration process performed when a DEC104S is first powered up, detects the current configuration settings and restores the appropriate control. Once this initialisation procedure is complete, the card can be controlled or configured from the card edge, the frame's local control panel, from a remote control panel or from Statesman.

Card edge controls

The front edge of the card provides LED status and power rail monitoring, menu selection, rotary set-up controls and a ten-digit visual status display.



In general the six-lever switch changes mode or options whilst the SELECT switch is used to select one of the main configuration menus and the ADJ shaft encoder is used to assign values to configuration variables.

A change made using the shaft encoder is generally implemented immediately and there is no need for a separate save or enter function.

Displaying module type and firmware

To display the module type and firmware rotate switch (SEL) to position A or E.

SEL 8 or 9	Description
Module type	DEC104S1.00

Setting video standard and decoder options

The six-lever switch to the left of the card edge matrix display is used to configure the main options.

10 bit or 8 bit processing

525, 625 or automatic line standard selection

Composite or Y/C decoder input

VBI blanking ON/OFF

Lever	UP	DOWN
Lever 1	Automatic switching between 10 and 8 bit mode	10 or 8 bit mode selected manually using lever 5
Lever 2	Automatic switching between 625 and 525 line standard	625 or 525 standard selected manually using lever 6
Lever 3	Composite input	Y/C (S-video) input.
Lever 4	VBI data passed unprocessed on luminance channel	VBI data blanked
Lever 5	Forced to 10 bit	Forced to 8 bit
Lever 6	Forced to PAL 625 line standard	Forced to NTSC 525 line standard

Forcing the video standard

The video standard can be forced by using jumper lever 6 in conjunction with lever 2 of the six-lever switch.

Note: 10 bit mode is not available in NTSC when Y/C is selected. Use the DEC102S for 10 bit mode with NTSC inputs in Y/C format.
Vertical Blanking Interval data is normally present in PAL on lines 7-22 and 319-335 and in NTSC on lines 10-20 and 273-282.

Setting decoder modes

There are five decoder modes, selected by a combination of the four-lever switch, Adjust control and on-board jumpers:

Comb – 10 bit adaptive comb decoder mode

Bandsplit – 10 bit HIGH QUALITY bandsplit mode for PAL inputs only

Simple – 8 bit decoder mode

10 bit YC – Y/C (S-video) mode selected for well-timed inputs

8 bit YC – Y/C (S-video) mode selected for inputs with less stable timing

If switch lever 1 is left in the UP position 10 bit or 8 bit mode is selected automatically. If switch lever 1 is left in the DOWN position the choice can be made using lever 5.

Link	Position	Function
Lever 5	Board centre	Manually select 10 or 8 bit operation when piano switch 1 is DOWN Lever down – forces 8 bit operation Lever up – forces 10 bit operation

The five decoder modes and the required lever, jumper and ADJ control settings are summarised below:

Desired Mode	SEL 7 Display Text	Rotate ADJ	Mode lever and jumper settings
Composite, 10 bit	Comb	Yes	Lever 3 UP and Lever 1 UP (or Lever 1 DOWN with lever 5 UP in 10 bit position)
Composite, 10 bit	Bandsplit	Yes	Lever 3 UP and Lever 1 UP (or Lever 1 DOWN with lever 5 UP in 10 bit position)
Composite, 8 bit	Simple	No	Lever 3 UP and Lever 1 UP (or Lever 1 DOWN with lever 5 DOWN in 8 bit position)
Y/C, 10 bit	10 bit YC	No	Lever 3 DOWN and Lever 1 UP (or Lever 1 DOWN with lever 5 UP in 10 bit position)
Y/C, 8 bit	8 bit YC	No	Lever 3 DOWN and Lever 1 UP (or Lever 1 DOWN with lever 5 DOWN in 8 bit position)

Notes: Bandsplit is only available with PAL inputs in 10 bit mode.
10 bit mode is not available in NTSC when Y/C is selected. Use the DEC102S for 10 bit mode with NTSC inputs in Y/C format.

Setting gain and black level

Use rotary switch (SEL) positions 0 to 4 and the shaft encoder to change the following:

Luminance gain and offset (black level)

Chrominance gains

The gain and offset adjustments are independent for 8 and 10 bit modes as well as comb, bandsplit and Y/C modes. For example, if the unit is set up in 10 bit mode and subsequently adjusted in 8 bit mode, the 10 bit adjustments are maintained and will be restored when 10 bit operation is resumed.

There are effectively five sets of independent gain and offset adjustments; 8 bit composite, 10 bit comb, 10 bit bandsplit, 8 bit Y/C and 10 bit Y/C.

SEL	Display Text	Description
0	Ygain% 100	The shaft encoder can be used to adjust the luminance gain.
1	Yoff+mV 3	The shaft encoder can be used to adjust the luminance offset (black level).
2	CGain% 100	The shaft encoder can be used to adjust both the U and V chrominance gains.
3	Ugain% 100	The shaft encoder can be used to adjust the U chrominance gain.
4	Vgain% 100	The shaft encoder can be used to adjust the V chrominance gain.

Note: The displayed number varies as the shaft encoder is rotated to give an indication of the setting relative to the factory default

Select position 0 (Ygain) with the SEL control to allow the shaft encoder to adjust the luminance gain from 0 to 200%.

Select position 1 (Yoff) with the SEL control to allow the shaft encoder to adjust the black level from -30 to +385mV.

Select position 2 (Cgain) with the SEL control to allow the shaft encoder to adjust the overall chrominance gain from 0 to 200%.

Select position 3 (Ugain) with the SEL control to allow the shaft encoder to adjust the U chrominance gain from 0 to 200%.

Select position 4 (Vgain) with the SEL control to allow the shaft encoder to adjust the V chrominance gain from 0 to 200%.

Adjusting signal timing

Use rotary switch (SEL) positions 5, 6, 8 and 9 together with the shaft encoder to change the following:

Output timing relative to the active reference

Chroma phase relative to burst (10 bit mode only)

Input video timing (10 bit mode only)

The horizontal and vertical timing adjustments relative to the active reference are separate for 625 and 525 line operation. The settings for composite and Y/C (S-video) phase are also stored separately, as are the phase settings for PAL and NTSC. This gives a total of four separate phase adjustments, two each in PAL and NTSC.

All these parameters are automatically maintained when the unit is powered off and restored when the unit is powered back on.

SEL	Display Text	Description
5	H Pos 0	The shaft encoder adjusts the output video timing relative to the active analogue timing reference in increments of 37ns. When the maximum adjustment of one line is reached the value wraps round to zero and the Vpos adjustment is modified.
6	V Pos 0	The shaft encoder adjusts the output video timing relative to the active analogue timing reference in increments of whole video lines. When the maximum adjustment of one frame is reached the value wraps round to zero.
8	Phase 0 (version number shown in 8 bit mode)	In 10 bit mode chroma phase relative to burst can be adjusted in steps of approximately 0.1° . The display shows the difference from the default setting in whole degrees.
9	H del +0 (version number shown in 8 bit mode)	In 10 bit mode the timing of the input video relative to the input syncs can be adjusted in 37ns steps. The range is -128 to +127, giving approximately +/- 4.75 microseconds relative to the factory default timing. The display indicates the number of adjustment steps used. Do not leave the SEL switch in position 9 as it also used as a power-up factory reset function.

The active output timing reference

The horizontal and vertical timing adjustments operate relative to one of three analogue timing references. These are an external reference, the composite or YC input or an internal free-running clock. Which of these is the active reference is dependent on the presence of an external reference or whether an 8 bit or 10 bit mode is in operation.

When an external analogue timing reference is present serial output timing is maintained relative to the external analogue reference.

When no external analogue timing reference present the serial output timing depends on whether the decoder is in 10 or 8 bit mode. In 10 bit mode the serial output is timed to the composite or Y/C input. In 8 bit mode the output is timed to a free running factory set clock.

The following tables summarises the possible output timing reference sources:

Active timing reference	Ext Ref	Mode
External analogue input	Present	10 or 8 bit
Composite or Y/C input	Not present	10 bit
Free running internal clock	Not present	8 bit

The horizontal delay adjustment varies the timing of the input video relative to input syncs and blanking in 10 bit mode whichever source is the active reference.

Mode	Input video timing
10 bit	Relative to input video syncs and blanking
8 bit	No horizontal delay available

Adjusting horizontal and vertical timing

The output timing can be adjusted through an entire frame using the Vpos and Hpos settings.

Increasing the vertical position setting will delay the output relative to the reference in increments of one video line. Select position 6 (V Pos) with the SEL control to allow the shaft encoder to adjust the vertical output timing. The range of adjustment is one video frame. When the maximum adjustment is reached the value wraps around to zero.

Increasing the horizontal position setting will delay the output relative to the reference in increments of 37ns. Select position 5 (H Pos) with the SEL control to allow the shaft encoder to adjust the horizontal output timing. The range of adjustment is one video line. When the Hpos setting reaches the end of a video line it wraps round and the Vpos setting is changed to provide continuous adjustment.

With an external analogue timing reference present the delay through the board depends on these adjustments and the relative timing of the serial input and the analogue reference. When both horizontal and vertical position settings are zero the delay through the board will be minimum and the serial output will be timed to the analogue reference as per ITU-R BT.601. The minimum delay through the board is approximately 1.7 lines in 10 bit mode and 0.7 lines in 8 bit mode.

Using the phase control

Select position 8 (Phase) with the SEL control to allow the shaft encoder to adjust the chroma phase relative to burst. This adjustment is available in 10 bit mode only. The range of adjustment is 360 degrees, in steps of roughly 0.1degrees. When the maximum adjustment is reached the value wraps around to zero.

Note: The firmware version number is shown in 8 bit mode when SEL 8 is selected.

The timing adjustments are separate for 625 and 525 line operation and the settings are automatically maintained when the unit is powered off and restored when the unit is powered back on.

Adjusting input video timing

The horizontal delay adjustment varies the timing of the input video relative to input syncs and blanking in 10 bit mode whichever source is the active reference.

Mode	Input video timing
10 bit	Relative to input video syncs and blanking
8 bit	No horizontal delay available

Select position 9 (H del) with the SEL control to allow the shaft encoder to adjust the input video timing with respect to the input video syncs in steps of 37ns. This adjustment is available in 10 bit mode only.

Note: The firmware version number is shown in 8 bit mode when SEL 9 is selected. Do not leave the SEL switch in position 9 as it also used as a power-up factory reset function.

The available range is -128 to +127 steps (roughly +/- 4.5 microseconds) relative to the factory default position. The value cannot be adjusted outside this range.

Setting 525 (NTSC) Setup

Use rotary switch (SEL) position 7 together with the shaft encoder in 525(NTSC) mode **ONLY** to switch Setup (pedestal) compensation ON or OFF:

SEL 7 Display Text	Description
Setup on	7.5 IRE subtracted from black level, gain increased
Setup off	Black level and gain settings assume no 7.5 IRE offset

Note: When the board is in 525 line (NTSC) mode, the shaft encoder can be used to switch setup (pedestal) compensation on and off. When setup compensation is ON the display will show “setup on”. The 7.5 IRE offset will be subtracted from the black level and the gain will be increased to compensate. This does not affect the Y Gain and Y Offset settings. When setup compensation is OFF the display will show “setup off”. The black level and gain will be set assuming no 7.5 IRE offset, in the same way as for PAL inputs. The setup mode is preserved through 625-line operation and power down.

Restoring factory defaults

If required all settings can be returned to default values. This is done by powering the module with rotary switch (SEL) in position 9 and piano switch lever 4 UP. The display text will be 'DEFAULTS?' To restore default settings set piano switch lever 4 DOWN.

Note: Moving the rotary switch away from position 9 will set the board to normal operation without overwriting the previous settings. On no account should the SEL switch be left in position 9.

5 Hardware installation

The DEC104S single height module uses the RM01, RM23, RM24, RM25 and RM27 rear connectors and fits into all Crystal Vision rack frames. All modules can be plugged in and removed while the frame is powered without damage.

Note: The RM25 can only be used in the Indigo 2 and Indigo 4 frames.

5.1 Rear modules and signal I/O

The Indigo 4U frame will house up to 24 single height modules with up to three power supplies. The FR2AV and Indigo 2U frame will house up to 12 single height modules and dual power supplies. The FR1AV and Indigo 1U frame will house 6 single height modules and a single power supply. The DTBAV and Indigo 1U high Desk Top Box both have a built-in power supply and will house up to 2 single height modules.

RM01

RM01 modular rear connector	Description
 <p>The diagram shows a green modular rear connector with six BNC ports. From left to right, the ports are labeled: SYNC IN, Y IN, NTSC/PAL/C IN, SDI OUT, SDI OUT, and SDI OUT. The entire connector is labeled RM01 below the ports.</p>	<p>RM01(ZLA00239 artwork)</p> <ul style="list-style-type: none"> • 24 DEC104 modules per Indigo 4 frame • 12 per FR2AV or 2U Indigo frame • Composite sync loop through output not available • All frame slots can be used

Note: One DEC104S card can be fitted to each RM01 rear module.

BNC	Function
SDI OUT (1)	Serial Digital Output
SDI OUT (2)	Serial Digital Output
SDI OUT (3)	Serial Digital Output
NTSC/PAL/C IN	Analogue Composite Video or C Input
Y IN	Analogue Y plus Sync Input (active in Y/C input mode only)
SYNC IN	Composite Sync (B & B) Input

Note: An audio follow pulse is available on GPI5.

For details of fitting rear connectors please refer to the appropriate frame manual.

RM23

RM23 modular rear connector	Description
	<p>RM23 (ZLA00245 artwork)</p> <ul style="list-style-type: none"> • 24 DEC104 modules per Indigo 4 frame • 12 per FR2AV or 2U Indigo frame • Composite sync loop through output not available • All frame slots can be used

BNC	Function
SYNC IN	Composite Sync (B & B) Input
SDI OUT	Serial Digital Output
SDI OUT	Serial Digital Output
NTSC/PAL/C IN	Analogue Composite Video or C Input
Y IN	Analogue Y plus Sync Input (active in Y/C input mode only)
SYNC IN LOOP	Composite Sync (B & B) Input Loop-Through

Note: An audio follow pulse is available on GPI5.

RM24

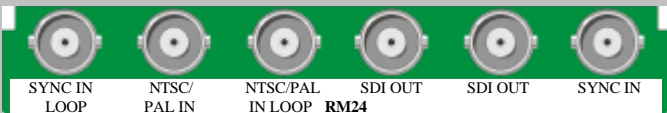
RM24 modular rear connector	Description
	<p>RM24 (ZLA00247 artwork)</p> <ul style="list-style-type: none"> • 24 DEC104 modules per Indigo 4 frame • 12 per FR2AV or 2U Indigo frame • Composite sync loop through output not available <p>All frame slots can be used</p>

BNC	Function
SYNC IN	Composite Sync (B & B) Input
SDI OUT	Serial Digital Output
SDI OUT	Serial Digital Output
NTSC/PAL IN LOOP	Analogue Composite Video input Loop-Through
NTSC/PAL IN	Analogue Composite Video
SYNC IN LOOP	Composite Sync (B & B) Input Loop-Through

Note: An audio follow pulse is available on GPI5.

RM25

RM25 modular rear connector	Description
	<ul style="list-style-type: none"> • RM25 (ZLA00249 artwork) • 18 DEC104S modules per Indigo 4 frame • 9 DEC104S modules per FR2AV or 2U Indigo frame • 3 modules per rear connector • All connections available • Card 1 fits in slots 1, 5 and 9 • Card 2 fits in slots 2, 6 and 10 • Card 3 fits in slots 4, 8 and 12 <p>No card fits in 3, 7 or 11</p>

BNC	Function
SDI OUT	Serial Digital Output
SDI OUT	Serial Digital Output
PAL/NTSC/C IN	Analogue Composite Video or C input
PAL/NTSC/C/IN LOOP	Analogue Composite Video or C input Loop-Through
Y IN	Analogue Y plus Sync Input (active in Y/C input mode only)
SDI OUT	Serial Digital Output
SDI OUT	Serial Digital Output
SYNC IN LOOP	Composite Sync (B & B) Input Loop-Through
SYNC IN	Composite Sync (B & B) Input

Note: An audio follow pulse is available on GPI5.

RM27

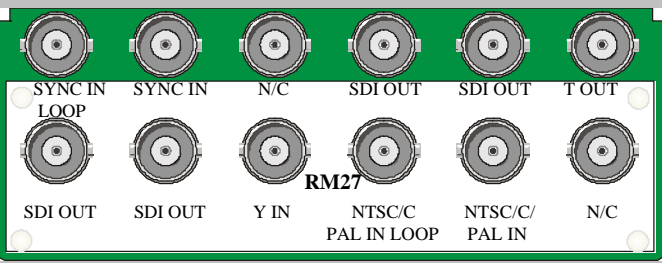
RM27 modular rear connector	Description
	RM27 (ZLA00257 artwork) <ul style="list-style-type: none"> • 12 DEC104S modules per Indigo 4 frame • 6 DEC104S modules per FR2AV or 2U Indigo frame • Odd numbered slots can be used

BNC	Function
T OUT	Audio Follow Pulse
SDI OUT	Serial Digital Output
SDI OUT	Serial Digital Output
N/C	No Connect
SYNC IN	Composite Sync (B & B) Input
SYNC IN LOOP	Composite Sync (B & B) Input Loop-Through
N/C	No Connect
NTSC/C/PAL/IN	Analogue Composite Video or C Input
NTSC/C/PAL IN LOOP	Analogue Composite Video or C Input Loop-Through
Y IN	Analogue Y plus Sync Input (active in Y/C input mode only)
SDI OUT	Serial Digital Output
SDI OUT	Serial Digital Output

Note: An audio follow pulse is available on GPI5.

5.2 Module configuration

The DEC104S has jumper links and analogue gain adjustments present on the module PCB. Many of the jumper links are set in conjunction with the front card edge controls. Analogue gain settings are pre-set at the factory and should not require re-adjustment.

Loop or terminate the composite video input

The composite video input may be terminated with 75Ω or allowed to provide a loop through output. Set jumper link PL2 at the right hand middle of the module to the left (away from the edge connector) to terminate the composite video input. Set jumper PL2 to the right (towards the edge connector) for a loop through output.

Link	Position	Select loop through or termination of reference syncs
PL2	Middle near edge connector	Link towards edge connector – composite video input looped through Link away from the edge connector – composite video input terminated on board

Loop or terminate the external reference

The external analogue reference may be terminated with 75Ω or allowed to provide a loop through output. Set jumper link PL3 at the bottom right hand corner of the module to the left (away from the edge connector) to terminate the external reference. Set jumper PL3 to the right (towards the edge connector) for a loop through output.

Link	Position	Select loop through or termination of reference syncs
PL3	Bottom right hand corner	Link towards edge connector – ext syncs looped through Link away from the edge connector – ext syncs terminated on board

6 Trouble shooting

Card edge monitoring

Once the start-up initialisation procedure is complete, the DEC104S can be controlled or configured from the card edge, from an active control panel or the Statesman PC interface. This chapter will concentrate on the card edge monitoring LEDs.

Status LEDs

Board edge LEDs provide status reporting and may be useful when fault finding.

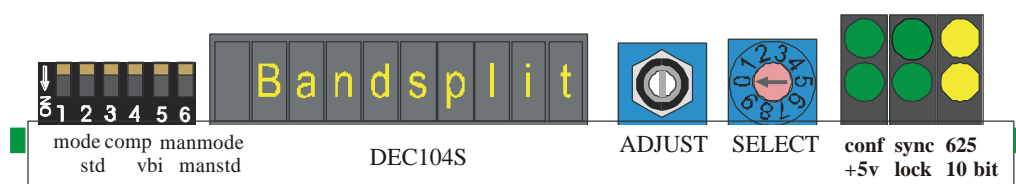

DEC104S front view showing controls and LEDs

The following table summarises the card edge LED functions and colours:

LED Colour	Position	Description
Green	Conf	Illuminates when board power-on configuration is complete
Green	Sync	Illuminates when analogue timing reference is absent. The board output will be timed relative to the composite or Y input in 10 bit mode and a free running clock in 8 bit mode.
Yellow	625	Illuminates when board is in 625 line mode
Green	+5V	Illuminates when the board is powered
Green	Lock	Illuminates when the composite or Y input is present
Yellow	10 bit	Illuminates when the board is 10 bit mode

Fault finding guide

The Power OK LEDs are not illuminated

Check that the frame PSU is functioning – refer to the appropriate frame manual for detailed information

There is no video output

Check that a valid input is present (Lock LED ON) and that any cabling is intact

The card no longer responds to Statesman/front panel control

- Check that the card is seated correctly and that the Power OK LED is lit
- Check that the card-edge Rx and Tx LEDs flash (Comms LED in an Indigo frame) when Statesman communication control is attempted
- Check any active control panel/Statesman cabling
- Check if the control panel/Statesman can control another card in the same rack
- If necessary re-set the card

The video output is not synchronous with other sources

- Check that a valid synchronous reference is connected, that the Sync LED is lit and that the correct video standard is selected
- Check that output phasing is set correctly

The video output is disturbed when the horizontal delay is adjusted

If the chroma burst is absent for more than a second during adjustment, the input video timing logic automatically may reset itself a number of times. Because of this there will be a periodic disturbance of the output for several seconds, if the input timing is set so far out that the burst is not detected.

Statesman settings change unexpectedly

Active control panel or card edge control settings may have overridden Statesman settings if they were changed more recently

Card edge settings have changed unexpectedly

Statesman or active control panel settings may have overridden card edge control settings if they were changed more recently

Active control panel settings change unexpectedly

Statesman or card edge control settings may have overridden control panel settings if they were changed more recently

Active control panel and/or Statesman does not work as expected

Check that a unique node address is being used in the frame the module is fitted into

Module powers up with invalid video

Check that the SEL switch has not been left in position 9 (factory default recall)

Re-setting the card

If required, the card may be reset by simply removing the rack power and re-applying power after a few seconds or by removing the card from the rack then re-inserting the card. It is usually safe to reinsert the card whilst the rack is powered.

It is also possible to recall factory defaults by following the procedure at the end of the Card-edge operation chapter.

7 Specification

General

Dimensions	100mm x 266mm module with DIN 41612 connector
Weight	200g
Power consumption	8W

Inputs

Analogue video input	Composite or Y/C video input, 1 volt with syncs 625 line PAL or 525 line NTSC
Analogue reference	Analogue black and burst, mixed syncs or video. Amplitude of syncs 150mV to 4V Link on PCB selects 75 Ohm termination or high impedance with loop through (via PCB)
Blanking	To analogue PAL/NTSC specifications with selectable VBI blanking PAL lines 7 to 22 and 319 to 335 NTSC lines 10 to 20 and 273 to 282

Outputs

Audio follow output	TTL output, pulse length same as delay through store
Video SDI output	4 x 270Mb/s serial digital to EBU Tech 3267-E and SMPTE-259M

Analogue performance

Frequency response with comb active	+/- 0.3dB to 5.5MHz
Gain error	<1%
Differential phase and gain	<1.5°, <1.5% (10 bit mode)

Ordering information

DEC104S	10 bit PAL/NTSC or Y/C to SDI adaptive comb decoder with TBC/framestore and additional bandsplit decoding in PAL
RM01	Single height rear connector
RM23	Single height rear connector
RM24	Single height rear connector
RM25	Triple height rear connector
RM27	Double height rear connector
Indigo 4	4U frame for up to 24 modules
Indigo 2	2U frame for up to 12 modules
Indigo 1	1U frame for up to 6 modules
Indigo DT	1U Desk top box for up to 2 modules
Indigo 2A	2U frame, Statesman enabled, with active control panel for up 12 modules
Indigo 1A	1U frame, Statesman enabled, with active control panel for up 6 modules
Indigo DTA	1U Desk top box, Statesman enabled, with active control panel for up 2 modules
Indigo 4S	Statesman enabled only 4U frame for up to 24 modules
Indigo 2S	Statesman enabled only 2U frame for up to 12 modules
Indigo 1S	Statesman enabled only 1U frame for up to 6 modules
Indigo DTS	Statesman enabled only 1U Desk top box for up to 2 modules