

digital keying modular
interface audio
converters analogue video

SYN HD

HD/SD Synchroniser

USER MANUAL



Contents

1	Introduction	3
1.1	Operating modes	4
	Synchroniser mode	4
	Delay mode	4
	Analogue timing reference	5
	Audio follow pulse	5
	Freezing the picture	5
	SDI loss behaviour	5
	Vertical lock	5
	EDH	5
2	Hardware installation	6
2.1	Rear modules and signal I/O	6
	Rear module connections with RM34	6
2.2	Module configuration	7
2.3	General Purpose Interface (GPI)	7
3	Card edge operation	10
3.1	Card edge controls	10
	Card edge buttons	10
	Card edge rotary control	10
	Reading card edge LEDs	11
	Navigating card edge menus	11
3.2	Card edge configuration	12
	Menu Tree	12
	Card edge status	13
	Delay menu	14

Control menu	15
Preset menu	16
4 Using the front control panel	18
4.1 Module selected	18
Updating the display	20
4.2 The SYN HD active panel menu structure	20
SYN HD Menu Structure	21
Delay Menu	21
Control Menu	23
Selecting the operating Mode	24
Reset (factory reset and defaults)	25
Preset Menu	25
Status	26
5 Statesman	27
5.1 Statesman operation	27
Status and Delay tab	28
Timing Adjustment	28
Presets and Control tab	30
Selecting the operating Mode	30
6 Trouble shooting	32
6.1 Card edge status LEDs	32
Basic fault finding guide	33
7 Specification	34

Revision 1.	Correction to video delay table, page 14	27-07-07
Revision 2.	Wording 'line rate' amended to be 'field rate', page 4-5	11-05-09

1 Introduction

SYN HD is a High Definition/Standard Definition serial digital synchroniser/delay module with two outputs and two input loop-throughs. There is also an audio follow output, and input for an external analogue reference. It has two fields of output timing adjustment and a short minimum delay of 2 μ s.

There are two operational modes: synchroniser and delay line. In synchroniser mode it will automatically correct the incoming frame rate and any delay by taking its timing from the analogue reference. Where input and output frame rates are locked together it can synchronise sources containing embedded audio.

Delay line mode is ideal when the frame rate is correct but the source has been delayed by processing.

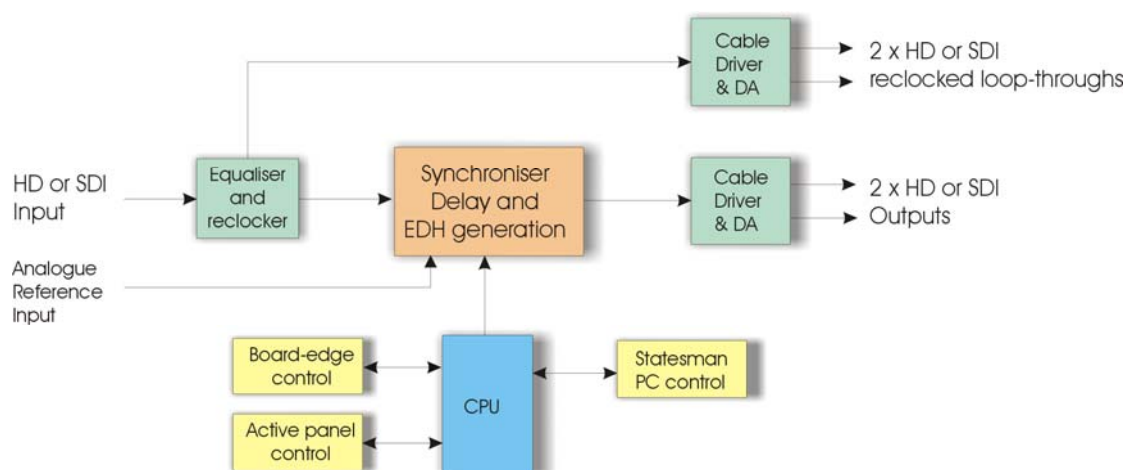

SYN HD block diagram

The main features are as follows:

- Frame or line synchroniser or use as a fixed delay line
- Full vertical and horizontal adjustment from 0 to 2 fields in any mode
- Fast lock after up-stream switch
- Cross-lock feature
- Selectable output on input failure
- EDH generation
- Audio follow control output
- Passes embedded audio (when output locked to input)
- Two synchronised/delayed outputs and two input loop-through outputs
- Fits in standard frames alongside HD, SD and audio products

SYN HD is a 100mm x 266mm module, which fits in the four standard frames and can be integrated with any board from the company's full product range. It uses the RM34 rear connector.

The serial digital output has virtually no output jitter (less than 0.2U at 1kHz SD and 0.2UI at 100kHz HD), both when used as a synchroniser (with a stable analogue reference) and when used as a delay line without a reference. Only in delay mode can jitter on the SDI input affect the output, but even then all high frequency jitter is removed by an internal phase-locked-loop.

Picture disturbances on untimed input cuts are avoided by SYN HD's dual switching scheme. In most cases switching will occur on line 7 with no picture disturbance or loss of vertical interval information such as embedded audio. Should the switch occur later, the switching point will be before the start of active video thus preserving the picture information but at the expense of any vertical interval data. The module regenerates all the video sync information in its output data stream and will always produce legal video. It will pass ancillary data sync word sequences, but not isolated sync word values.

There is a choice of black, blue or field/frame freeze with or without a delay on input failure. Indication is also given if the delay between the input video and external reference is shorter than the blanking period of the input video.

1.1 Operating modes

Synchroniser mode

In Syncro (synchroniser) mode the unit takes its timing from the analogue external reference and will automatically synchronise sources with or without embedded audio between 0 and 2 fields. Synchroniser mode is ideal for external sources that are not timed to station references such as satellite or remote contribution feeds.

The timing can be adjusted through an entire frame using horizontal (fine) and vertical (line increments) settings. Increasing the vertical setting will delay the output relative to the reference in increments of one video line. Increasing the horizontal setting will increase this delay in samples or increments of approximately 74ns for SD and 13.5ns for HD. In synchroniser mode the total delay through the board will depend on this adjustment and the relative timing of the serial input and the analogue reference.

Should the reference be removed or the board powered without a connected reference input the SYN HD will free-run at the previous received field rate. Another important feature of the SYN HD is its ability to cross-lock when both the reference input and video input are of the same field rate. This means that a High Definition video input can be referenced to either a tri-level sync or black and burst reference and likewise a Standard Definition video input can also be referenced to either black and burst or tri-level syncs.

Delay mode

In delay mode, timing is derived only from the video input. Typical applications are where a source passes through a processor such as a DVE, chroma keyer or standards converter where the delay can be a few microseconds, multiple lines or up to two fields.

The timing can be adjusted through an entire frame using the vertical and horizontal settings. When both settings are at their lowest the board will be set for the minimum delay (input to output) of approximately 2 μ s. Increasing the vertical setting will increase this delay in increments of one video line. Increasing the horizontal setting will increase

the delay in sample increments. The maximum setting of both controls will provide a delay of one frame plus approximately 2 μ s.

In either mode the video delay remains fully adjustable over two complete fields. This allows the output of the SYN HD to be timed into any edit suite irrespective of the timing of the black and burst reference used in synchroniser mode.

Analogue timing reference

The SYN HD provides a synchronisation function that allows the digital output to be timed to an analogue reference. The analogue reference can be tri-level syncs, video or composite syncs, although composite black and burst plus 300mV syncs into 75 Ohm as per EBU N14-1988 are preferred. When cross locking it is necessary that both video input and reference share the same field rate.

Audio follow pulse

To allow an audio delay to track the delay through the SYN HD, a TTL level pulse is provided. This pulse is output every frame. The length of the pulse (the time between the rising and falling edges) is the same as the delay through the store on the SYN HD.

Freezing the picture

The type of picture freeze used when the freeze command is given may be selected from frame, field 1 and field 2. If there is movement between both fields a frame freeze may show movement judder. A field freeze works by repeating the same field to produce a synthetic frame of video, without movement judder. However a field freeze is more likely to show jagged edges on near horizontal lines.

SDI loss behaviour

Behaviour after a loss of input can be selected from a list. These are blue, black, delay then blue, delay then black or picture freeze. The user can specify to show the last good whole frame in which failure happened (useful for diagnostic purposes) or field 1 or 2 of the last frame. This behaviour will be determined by the output freeze setting.

Vertical lock

SYN HD synchronises at three separate points within each field or frame: at the start of the field or frame, just after the switching point and at the start of the active field or frame. Re-synchronising just after the switching point allows SYN HD to cope seamlessly with switches on the input that are between synchronous sources and that occur at the switching point. Re-synchronising at the start of the active field or frame allows SYN HD to avoid picture disturbances for switches on the input that are between nominally timed sources and that occur in vertical blanking.

EDH

EDH information is regenerated and inserted into the output video. The output video will always be correctly defined.

2 Hardware installation

The SYN HD single height module uses the RM34 rear connector that will fit into all Crystal Vision rack frames. All modules can be plugged in and removed while the frame is powered without damage.

2.1 Rear modules and signal I/O

The 4U Indigo 4 frame will house up to 24 single height modules with up to three power supplies. The 2U Indigo 2 frame will house up to 12 single height modules and dual power supplies. The 1U Indigo 1 frame will house six single height modules and a single power supply. The Indigo DT desktop boxes both have a built-in power supply and will house up to two single height modules.

Note: For details of fitting rear connectors please refer to the appropriate frame manual

Rear module connections with RM34

The RM34 being a single height rear module connector will allow maximum packing density with the maximum number of outputs available.

RM34 rear module connector	Description
	RM34 <ul style="list-style-type: none"> • 24 SYN HD modules per Indigo 4 frame • 12 per Indigo 2 • Six per Indigo 1 frame • 2 per Indigo DT • All frame slots can be used

BNC	I/O assignment
HD/SD OUT	Scaler Serial Digital output
HD/SD OUT	Scaler Serial Digital output
HD/SD IN LOOP	High Definition/Standard Definition Serial Digital Input reclocked loop-through
HD/SD IN LOOP	High Definition/Standard Definition Serial Digital Input reclocked loop-through
SYNC IN	Reference input, Black and Burst or tri-level syncs
HD/SD INPUT	High Definition/Standard Definition Serial Digital Input

2.2 Module configuration

There is only one link on the SYN HD that can be set by the user. This is PL7, which is situated beside the rear board connector. When linked PL7 will terminate the reference input with 75 ohm. For high impedance reference input the link on PL7 should be stowed on a single pin for safekeeping.

2.3 General Purpose Interface (GPI)

Each frame slot has up to six connections 'a-f' for GPI control and monitoring. These connections are available at the rear of the frame on the 26-way D-Type remote connectors.

GPI		Low (<1V)	High (+5V)
0	'a'		
1	'b'		GPI recall of Presets
2	'c'		a,b,c high = Preset1, a,b,c low = Preset8
3	'd'		No function at present
4	'e'		Reference disconnected or missing
5	'f'		Audio follow pulse

As supplied, each GPI output has a 270Ω resistor in series with its output. This allows for an external LED to be driven, connected to a DC voltage of +5V.

Each General Purpose Input (GPI) is fitted with a 6800Ω resistor connected to the internal +5V.

4U frame GPI connections

GPI lines 'a' to 'f' of each card connect to two of eight rear remote connectors as follows:

Slot no.		'a' pin	'b' pin	'c' pin	'd' pin	'e' pin	'f' pin
1	Upper	8 (1)	9 (1)	18 (1)	26 (1)	19 (2)	20 (2)
2		7 (1)	16 (1)	17 (1)	25 (1)	10 (2)	11 (2)
3		8 (3)	9 (3)	18 (3)	26 (3)	19 (4)	20 (4)
4		7 (3)	16 (3)	17 (3)	25 (3)	10 (4)	11 (4)
5		5 (1)	6 (1)	15 (1)	24 (1)	1 (2)	2 (2)
6		4 (1)	14 (1)	13 (1)	23 (1)	3 (2)	4 (2)
7		5 (3)	6 (3)	15 (3)	24 (3)	1 (4)	2 (4)
8		4 (3)	14 (3)	13 (3)	23 (3)	3 (4)	4 (4)
9		3 (1)	12 (1)	22 (1)	21 (1)	12 (2)	13 (2)
10		10 (1)	11 (1)	19 (1)	20 (1)	21 (2)	22 (2)
11		3 (3)	12 (3)	22 (3)	21 (3)	12 (4)	13 (4)
12		10 (3)	11 (3)	19 (3)	20 (3)	21 (4)	22 (4)

Table shows pin number (remote number)

Slot no.	'a' pin	'b' pin	'c' pin	'd' pin	'e' pin	'f' pin
1	8 (5)	9 (5)	18 (5)	26 (5)	19 (6)	20 (6)
2	7 (5)	16 (5)	17 (5)	25 (5)	10 (6)	11 (6)
3	8 (7)	9 (7)	18 (7)	26 (7)	19 (8)	20 (8)
4	7 (7)	16 (7)	17 (7)	25 (7)	10 (8)	11 (8)
5	5 (5)	6 (5)	15 (5)	24 (5)	1 (6)	2 (6)
6	4 (5)	14 (5)	13 (5)	23 (5)	3 (6)	4 (6)
7	5 (7)	6 (7)	15 (7)	24 (7)	1 (8)	2 (8)
8	4 (7)	14 (7)	13 (7)	23 (7)	3 (8)	4 (8)
9	3 (5)	12 (5)	22 (5)	21 (5)	12 (6)	13 (6)
10	10 (5)	11 (5)	19 (5)	20 (5)	21 (6)	22 (6)
11	3 (7)	12 (7)	22 (7)	21 (7)	12 (8)	13 (8)
12	10 (7)	11 (7)	19 (7)	20 (7)	21 (8)	22 (8)

Table shows pin number (remote number)

Note: Remote 1, Remote 3, Remote 5 and Remote 7 are 26-way high-density D-Type female sockets. Frame ground is pin 2 and +5V @500mA is pin 1 in each case.
Remote 2, Remote 4, Remote 6 and Remote 8 are 26-way high-density D-Type male plugs and frame ground is pin 6 in each case and +5V @500mA is pin 15 on Remote 2 and Remote 6.

Note: The +5V output is protected by self-resetting thermal fuses, which limit the total output current available from Remotes 1-4 to approximately 1A. Remotes 5-8 are similarly protected.

2U frame GPI connections

GPI lines 'a' to 'f' of each card connect to two of four rear remote connectors as follows:

Slot no.	'a' pin	'b' pin	'c' pin	'd' pin	'e' pin	'f' pin
1	8 (1)	9 (1)	18 (1)	26 (1)	19 (2)	20 (2)
2	7 (1)	16 (1)	17 (1)	25 (1)	10 (2)	11 (2)
3	8 (3)	9 (3)	18 (3)	26 (3)	19 (4)	20 (4)
4	7 (3)	16 (3)	17 (3)	25 (3)	10 (4)	11 (4)
5	5 (1)	6 (1)	15 (1)	24 (1)	1 (2)	2 (2)
6	4 (1)	14 (1)	13 (1)	23 (1)	3 (2)	4 (2)
7	5 (3)	6 (3)	15 (3)	24 (3)	1 (4)	2 (4)
8	4 (3)	14 (3)	13 (3)	23 (3)	3 (4)	4 (4)
9	3 (1)	12 (1)	22 (1)	21 (1)	12 (2)	13 (2)
10	10 (1)	11 (1)	19 (1)	20 (1)	21 (2)	22 (2)
11	3 (3)	12 (3)	22 (3)	21 (3)	12 (4)	13 (4)
12	10 (3)	11 (3)	19 (3)	20 (3)	21 (4)	22 (4)

Table shows pin number (remote number)

Note: Remote 1 and Remote 3 are 26-way high-density D-Type female sockets. Frame ground is pin 2 and +5V @500mA is pin 1 in each case.

Remote 2 and Remote 4 are 26-way high-density D-Type male plugs and frame ground is pin 6 in each case and +5V @500mA is pin 15 on Remote 2.

Note: The +5V output is protected by self-resetting thermal fuses, which limit the total output current available from Remotes 1-4 to approximately 1A.

1U frame GPI connections

GPI lines 'a' to 'f' of each card connect to two rear remote connectors as follows:

Slot no.	'a' pin	'b' pin	'c' pin	'd' pin	'e' pin	'f' pin
1	8 (1)	9 (1)	18 (1)	26 (1)	19 (2)	20 (2)
2	7 (1)	16 (1)	17 (1)	25 (1)	10 (2)	11 (2)
3	5 (1)	6 (1)	15 (1)	24 (1)	1 (2)	2 (2)
4	4 (1)	14 (1)	13 (1)	23 (1)	3 (2)	4 (2)
5	3 (1)	12 (1)	22 (1)	21 (1)	12 (2)	13 (2)
6	10 (1)	11 (1)	19 (1)	20 (1)	21 (2)	22 (2)

Table shows pin number (remote number)

Note: Remote 1: 26-way high-density D-Type female socket. Frame ground is pin 2 and +5V @500mA is pin 1.

Remote 2: 26-way high-density D-Type male plugs and frame ground is pin 6 and +5V @500mA is pin 15.

Note: The +5V output is protected by self-resetting thermal fuses, which limit the total output current available from Remotes 1-2 to approximately 1A.

Indigo DT desk top box GPI connections

GPI lines 'a' to 'f' of each card connect to two rear remote connectors as follows:

Slot no.	'a' pin	'b' pin	'c' pin	'd' pin	'e' pin	'f' pin
1	8 (1)	9 (1)	18 (1)	26 (1)	19 (2)	20 (2)
2	7 (1)	16 (1)	17 (1)	25 (1)	10 (2)	11 (2)

Table shows pin number (remote number)

Note: Remote 1: 26-way high-density D-Type female socket. Frame ground is pin 2 and +5V @500mA is pin 1.

Remote 2: 26-way high-density D-Type male plugs and frame ground is pin 6 and +5V @500mA is pin 15.

Note: The +5V output is protected by self-resetting thermal fuses, which limit the total output current available from Remotes 1-2 to approximately 1A.

3 Card edge operation

3.1 Card edge controls

Once the start-up initialisation procedure is complete, the SYN HD card can be controlled or configured from the card edge, the active control panel or the Statesman PC interface. This chapter will concentrate on the card edge controls.

The front edge of the card provides power rail monitoring, menu selection, variables adjustment and a ten-digit visual status display.

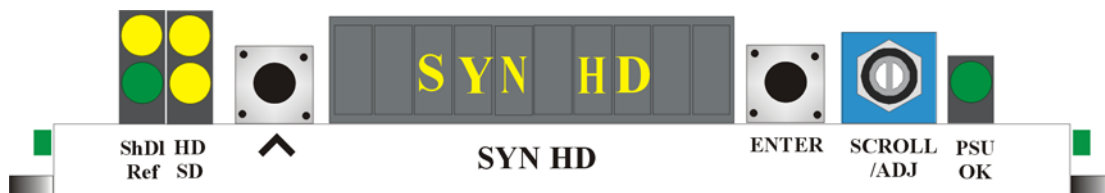

SYN HD front edge view

Card edge buttons

The two tactile push button switches allow the operator to navigate within the menu structure.

Button	Function	Normal state Up, Action Down
	Up Menu	Push to jump up a menu level or cancel a selection
ENTER	Select/Action	Push to select a menu and to action and confirm a change

Card edge rotary control

The board edge rotary encoder is used to navigate through the menu categories and adjust parameter values.

Control	Function
SCROLL /ADJUST	Rotate SCROLL to identify a menu category. In combination with the ENTER button select and ADJUST to change the current level or select a further option.

Note: The rotary control can access menus and parameter values by clockwise or anti-clockwise rotation.

Reading card edge LEDs

Card edge LEDs may be used in conjunction with status information from any connected remote status panel display or from Statesman if available.

Refer also to the trouble shooting chapter for more help with solving problems and monitoring status information.

The following table summarises the card edge LED functions and colours:

Name	LED Colour	Function when ON	Function when Off
HD	Yellow	Video input standard is HD (High Definition)	} Input not present
SD	Yellow	Video input standard is SD (Standard Definition)	
PSU	Green	Good power supply (PSU) rails.	One or more of the monitor supplies is out of specification
ShDI	Yellow	Short Delay (within blanking)	Delay longer than blanking period
Ref	Green	External reference present	No external reference present

Navigating card edge menus

To access the card edge menu system proceed as follows:

- Press the up-arrow [↑] until a top menu category is reached
- Rotate the SCROLL control until the desired menu category is found
- Push ENTER to enter the sub menus of that category
- Rotate SCROLL to select a sub menu
- Push ENTER to select the desired function. Selection will be indicated by the text being displayed in *italic* text
- Rotate ADJUST to make the desired change to the selected parameter. The display brightness will flash slowly to indicate that a change has been made and requires confirmation
- Push ENTER to action the change. The display will cease flashing
- Use the up-arrow [↑] and SCROLL control to navigate to further menus

Note: The displayed menu brightness will flash slowly if confirmation of a change is required.

3.2 Card edge configuration

Menu Tree

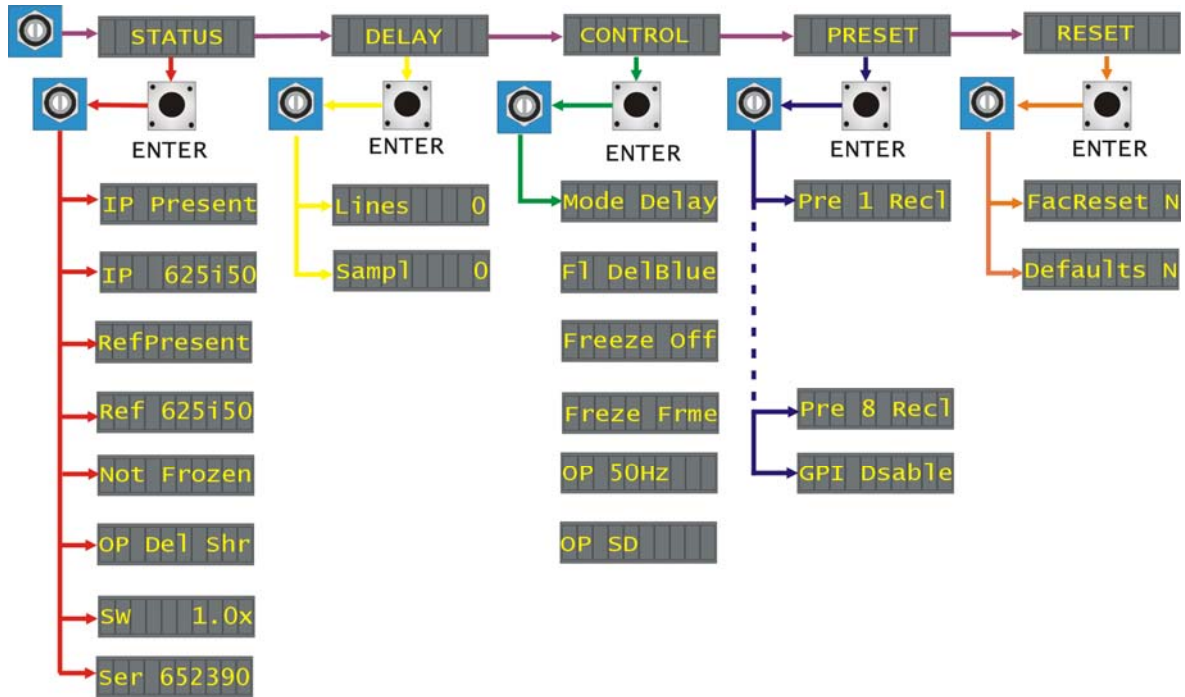

Tip. To reach the top menu push the  button repeatedly until a top menu is reached. Rotate the SCROLL control anti-clockwise until the STATUS menu appears.

Card edge status

From the STATUS top menu press ENTER then SCROLL to access the status menu options.

STATUS	Menu	Comment
IP Present	Valid video input present	Rotate the Scroll/Adj. control to show input video status. <i>IP Present, IP Missing.</i>
IP 625i50	Input video line rate	Rotate the Scroll/Adj. control to show input video standard. <i>625i, 525i, 720p, 1035i, 1080i, IP Missing</i>
RefPresent	External reference	Rotate the Scroll/Adj. control to show external reference present. <i>RefPresent, RefMissing</i>
Ref 625i50	External reference line rate	Rotate the Scroll/Adj. control to show reference line standard. <i>625i, 525i, 720p, 1035i, 1080i, RefMissing</i>
Not Frozen	Output video status	Rotate the Scroll/Adj. control to show output video status. <i>Not Frozen, OPVid Frzn</i>
OP Del Shr	Short delay	Rotate the Scroll/Adj. control to show Short delay between the external reference and the input video (less than blanking). <i>OP Del Shr, OP Del Lon</i>
SW 1.0x	Software	Rotate the Scroll/Adj. control to show the software currently fitted.
Ser 652390	Serial number	Rotate the Scroll/Adj. control to show the electronically stored serial number.

Input video standards and line rates supported by SYN HD

Standard	Line Rate Hz
PAL	50
NTSC	59.94, 60
720p	50, 59.94, 60
1035i	59.94, 60
1080i	50, 59.94 60

Delay menu

From this menu, adjustment of the picture horizontal and vertical picture timing can be made. The minimum delay through the SYN HD with both controls set to zero is approximately 2 μ s, with both controls set to a maximum of one complete frame plus 2 μ s available for all HD and SD standards.

DELAY	Menu	Comment
Lines 0	Video delay in lines	Rotate the Scroll/Adj. control to show the delay in lines menu. Press ENTER and rotate Adj. to set the delay in lines.
Samp1 0	Video delay in samples	Rotate the Scroll/Adj. control to show the delay in samples menu. Press ENTER and rotate Adj. to set the delay in samples.

Vertical position timing

Press F1 from the home menu and rotate the shaft control to display the delay in lines (vertical position) menu. The vertical position menu sets the number of whole lines the video is to be delayed in Delay Mode, or the vertical timing offset with respect to the reference input in Synchro Mode.

Standard	Lines
PAL	0-624
NTSC	0-524
720p 50	0-749
720p 59.94 / 60	0-749
1035i 59.94 / 60	0-1124
1080i 50	0-1124
1080i 59.94 / 60	0-1124

Horizontal position timing

Press F1 from the home menu to display the delay in samples (horizontal position) menu.

The Horizontal Position menu sets the number of samples/pixels the video is to be delayed in Delay Mode, or the vertical timing offset with respect to the reference input in Synchro Mode.

Standard	Samples
PAL	0-863
NTSC	0-857
720p 50	0-1979
720p 59.94 / 60	0-1649
1035i 59.94 / 60	0-2199
1080i 50	0-2639
1080i 59.94 / 60	0-2199

Control menu

The control menu is where the main operating parameters are found such as mode selection i.e. synchroniser or delay mode, output format in the event of no reference or signal input and board reset.

CONTROL	Menu	Comment
Mode Delay	Syncro/Delay mode	Rotate the Scroll/Adj. control to show mode selected. Press ENTER and rotate Scroll/Adj. to select. Press ENTER to select. Mode Syncr, Mode Delay.
F1 DelBlue	Output on Input fail	Rotate the Scroll/Adj. control to show the Output On Fail menu. Press ENTER and rotate Scroll/Adj. to select. Press ENTER to select. Fail Blue, Fail Black, F1 DelBlue, F1 DelBlck, Fail Frame
Freeze Off	Output Freeze	Rotate the Scroll/Adj. control to the Output Freeze menu. Press ENTER and rotate Scroll/Adj. to select. Press ENTER to force the output to be frozen. Freeze Off, Freeze On
Freze Frme	Output freeze selection	Rotate the Scroll/Adj. control to show Freeze Preference menu. Press ENTER to select and rotate Scroll/Adj. to select. Press ENTER to action. Freeze Fld1, Freeze Fld2, Freze Frme.
OP 50Hz	Output line rate with no inputs	Rotate the Scroll/Adj. control to show output video status. Not Frozen, OPVid Frzn
OP SD	Output standard with no inputs	Rotate the Scroll/Adj. control to show output video status. Not Frozen, OPVid Frzn

Preset menu

Up to eight set-ups may be stored for the board and recalled either from the board control, active front panel, Statesman or through the use of external GPIs. Presets store board set-up data including operating mode card status. The presets are numbered 1-8.

Note: Care should be taken when storing presets that the desired configuration is not changed by any external input prior to saving.

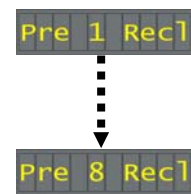
PRESET	Menu	Comment
	Save and recall Presets 1-8	Rotate the Scroll/Adj. control to show Preset Menu selected. Press ENTER and rotate Scroll/Adj. to select preset location. Press ENTER to select and rotate Scroll/Adj. to select Recall or Save Recall. Press ENTER to action.
GPI Disbld	Enable GPI control of presets	Selecting ENABLE allows the recall of previously saved user configurations via GPI inputs 0-3.

Reset (factory defaults)

The Reset button will return all parameters to their factory default levels.

Note: Reset will cause all user-stored configurations to be erased. To retain user stored configurations use the Defaults option

RESET	Menu	Comment
FacReset N		Rotate the Scroll/Adj. control to show Reset Menu selected. Press ENTER and rotate Scroll/Adj. to select Factory Reset. Press ENTER to select and rotate Scroll/Adj. to select Yes. Press ENTER to action. Indication is given that the card is being reset.
Defaults N		Rotate the Scroll/Adj. control to show Reset Menu selected. Press ENTER and rotate Scroll/Adj. to select Defaults. Press ENTER to select and rotate Scroll/Adj. to select Yes. Press ENTER to action. Indication is given that the card is being reset.

Parameter	Default value
Mode	Synchroniser
Output Freeze	Off
Output on frozen	Field 1
Output on Input fail	Blue
Output frame rate	Follows Input or 50Hz
Output format	Follows Input
GPI control	Disabled

4 Using the front control panel

4.1 Module selected

This operational guide assumes that the panel has been set up according to the Panel setup procedure described in the Crystal Vision Control Panel manual.

Note: It is **ESSENTIAL** that the Panel setup procedure is followed and any old or unknown passwords cleared prior to using the panel for the first time.

At power up, the two line 20-character screen will display 'Crystal Vision' followed by the firmware version number for the control panel. All eight control panel keys LEDs will illuminate.



The Crystal Vision control panel start up display

'Control Panel' then briefly replaces the version number display.

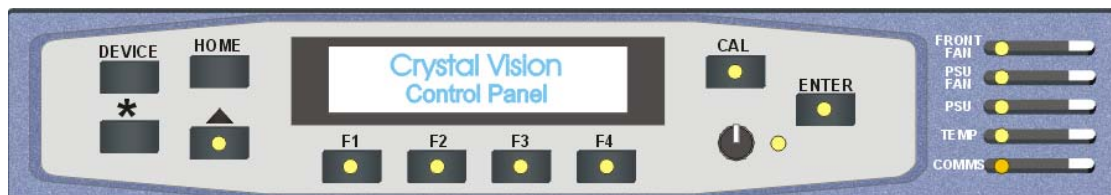

If the control panel firmware has been updated for Statesman control (version 1.5.0 or higher), Statesman Mode will be entered and the message, 'Press Cal to Exit' will be displayed and the CAL LED will light.



Statesman mode is entered by default

To continue with control panel operation or configuration, press the CAL key once. A second press of the CAL key will return to Statesman control.

The control panel will display the name of the card that first responds to the polling request together with its location number.

The location number consists of the frame number plus the card position in the frame.

Navigating the display

The functions assigned to control panel keys are:

- DEVICE – enters Device menu to select a card or show cards available / enters Panel setup when held down during power up / shows frame status when pressed from Statesman mode
- CAL – enters or leaves Statesman mode / enters panel diagnostics mode when held down during power up / updates the display
- Asterisk – enters board rename menu from the Device menu
- F1 to F4 – soft keys, function assigned within each menu
- HOME – moves the display to the home menu
- ENTER – accept current selection
- Upward arrow – used to move up the menu structure / enter lock panel menu from the Device menu
- Rotary control – shaft encoder used to select options or variable data

Note: Please refer to the Crystal Vision Control Panel manual for details of the Panel Setup, Lock Panel and Diagnostic menus.

Selecting SYN HD

To select a particular card in a frame, press the DEVICE key to go to the Device menu.

Note: There may be a delay whilst the frame is interrogated during which time 'No Cards Found' could be displayed.

The top line of the display will show 'Available Cards X', where X is the number of cards that have responded so far to the polling request.



The available cards menu

Rotate the shaft encoder and the bottom row will display the successfully polled cards by name and location or slot number.

In the example above, the card displayed is located in the first frame in slot number one.

When the desired card is selected press the ENTER key to access that card's HOME menu. The message shows that an SYN HD has been selected.



The SYN HD home menu

Updating the display

The values displayed on an active front panel are only updated when an adjustment is made and when changing menu level. If changes occur through the use of card edge controls or other remote control, the text displayed on the active front panel will not be updated immediately. If necessary, use the upward arrow to leave and then re-enter a menu to update the display.

4.2 The SYN HD active panel menu structure

At any time the main top-level menu (Home) is obtained by pressing the HOME key. From the home menu further selections can be made. Active function keys are indicated by their integrated LEDs illuminating.

The main top-level menus for the SYN HD module are obtained by pressing the F1- F4 keys from the HOME menu. Menu keys are illuminated when active and when further menus are available. The top-level menus are:

- Delay (video delay in lines and samples) – press F1
- Control (Delay/Sync Mode, Freeze, Factory defaults) – press F2
- Presets (User-defined configurations) – press F3
- Stats (Status) – press F4

When a sub menu has been selected, further options may be obtained by using the Shaft control to scroll through them. Once the desired option has been located a selection or value change can be made by either toggling the appropriate function key or by selecting and using the shaft control to alter a numerical value. A configuration change or value will be activated as the shaft control is rotated or function button is toggled. The variable being adjusted will appear in [brackets]. Pressing Enter will fix the new value.

The following chart shows the available SYN HD menus. The actual menus available may vary slightly as software is updated.

SYN HD Menu Structure

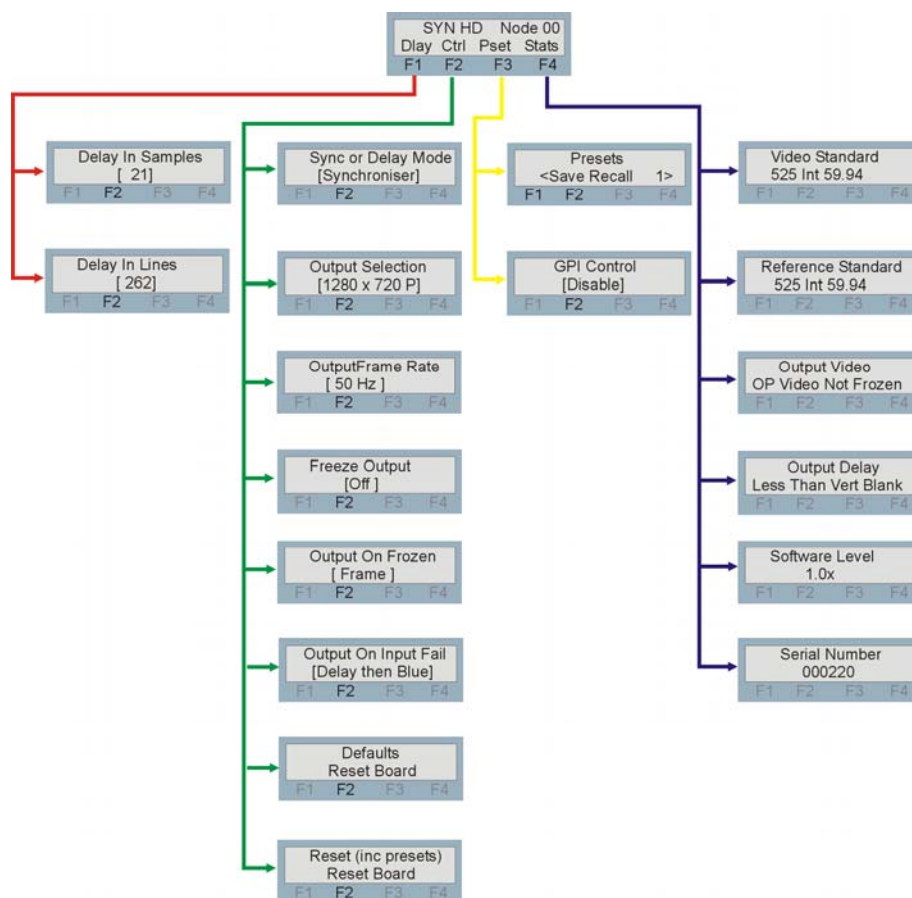

Delay Menu

From this menu adjustment of the horizontal and vertical picture timing can be made. The minimum delay through the SYN HD with both controls set to zero is approximately $2\mu\text{s}$, with both controls set to a maximum of one complete frame plus $2\mu\text{s}$ available for all HD and SD standards.

SYN HD delay menu	Description
	<p>From the Home menu, press F1 to select the Delay menu, which is then traversed by rotating the shaft control.</p>
	<p>Rotate shaft encoder to select Delay in Samples. Press F2 to select to change the value. Rotate shaft encoder to set the new value. See table for range. Press enter to accept the new value.</p>
	<p>Rotate shaft encoder to select Delay in Lines. Press F2 to select to change the value. Rotate shaft encoder to set the new value. See table for range. Press enter to accept the new value.</p>

Horizontal position timing

Press F1 from the home menu to display the Delay in Samples (Horizontal Position) menu.

The Horizontal Position menu sets the number of samples/pixels the video is to be delayed in Delay Mode, or the vertical timing offset with respect to the reference input in Synchro Mode.

Standard	Samples
PAL	0-863
NTSC	0-857
720p 50	0-1979
720p 59.94 / 60	0-1649
1035i 59.94 / 60	0-2199
1080i 50	0-2639
1080i 59.94 / 60	0-2199



Vertical position timing

Press F1 from the home menu and rotate the shaft control to display the Delay in Lines (vertical position) menu. The Vertical Position menu sets the number of whole lines the video is to be delayed in Delay Mode, or the vertical timing offset with respect to the reference input in Synchro Mode.

Standard	Lines
PAL	0-624
NTSC	0-524
720p 50	0-749
720p 59.94 / 60	0-749
1035i 59.94 / 60	0-1124
1080i 50	0-1124
1080i 59.94 / 60	0-1124

Control Menu

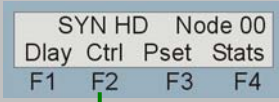
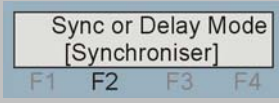
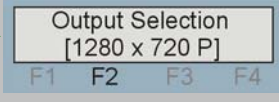
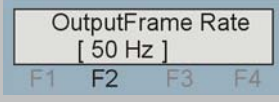
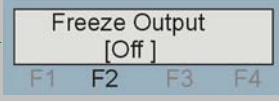
The control menu is where the main operating parameters are found such as mode selection i.e. synchroniser or delay mode, output format in the event of no reference or signal input and board reset.

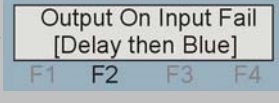
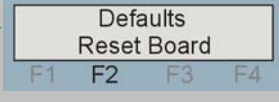
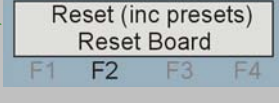
SYN HD Control menu	Description
	From the Home menu, press F2 to select the control menu, which is then traversed by rotating the shaft control.
	Rotate shaft encoder to select Sync or Delay mode. Press F2 to select to change the mode. Rotate shaft encoder to select <i>Synchroniser</i> or <i>Delay</i> . Press enter to accept the new configuration.
	Rotate shaft encoder to select Output Selection. Press F2 to select to change the selection. Rotate shaft encoder to select. Std Definition, 1280x720P, 1920x1080I, 1920x1035I. Press enter to accept the new selection. Not available when an input is present.
	Rotate shaft encoder to select the Output frame rate. Press F2 to select to change the selection. Rotate shaft encoder to select. 50Hz, 59.94Hz, 60Hz. Press enter to accept the new selection. Not available when an input or reference is present.
	Rotate shaft encoder to select Freeze Output. Press F2 to select to change the selection. Rotate shaft encoder to select. Off, On. Press enter to accept the new selection.
	Rotate shaft encoder to select Output On Frozen. Press F2 to select to change the selection. Rotate shaft encoder to select. Field 1, Field 2, Frame. Press enter to accept the new selection.
	Rotate shaft encoder to select Output on Input Fail. Press F2 to select to change the selection. Rotate shaft encoder to select. Blue, Black, Delay then Blue, Delay then Black, Freeze Frame. Press enter to accept the new selection.
	Rotate shaft encoder to select Defaults. Press F2 Are you sure? Y (F3). Press F3 to set to factory defaults.
	Rotate shaft encoder to select Reset. Press F2 Are you sure? Y (F3). Press F3 to implement a factory reset. Note. User stored configurations will be erased.

Selecting the operating Mode

The SYN HD has two modes of operation - synchronisation and delay line. In synchronisation mode the unit takes its timing from the analogue external reference and will automatically synchronise sources between 0 and 2 fields. In delay mode, timing is derived only from the SDI input.

If the input video should contain embedded audio, in delay mode this will be passed along with the video and be subject to the delay setting. In synchronising mode there is the likelihood of audio disturbance due to dropped or repeated frames.

Output Selection

With the video input present the SYN HD output format and frame rate will be the same as its input. With no input present the output can be set to any of the available video formats but at a frame rate determined by the external reference input. For instance, if the external reference is PAL black and burst the available output selection would be: Standard Definition PAL, 1280x720p 50Hz and 1920x1080i 50Hz.

Output Frame rate

With neither an external reference or video input present, the SYN HD will free run giving an output set by the Output selection and Output on Input Fail selection. The frame rate is then selectable in the Output Frame Rate menu from 50, 59.94 and 60Hz.

Freeze Output

This control sets the output to be frozen. The frozen output condition is selected by the Output On Frozen menu.

Output On Frozen

This menu is used to determine the type of freeze when Freeze Output is set to [on]. The type of picture freeze may be selected from frame, field 1 and field 2. If there is movement between both fields a frame freeze may show movement judder. A field freeze works by repeating the same field to produce a synthetic frame of video, without movement judder. However a field freeze is more likely to show jagged edges on near horizontal lines.

Output On Input Fail

Behaviour after a loss of input can be selected from Blue, Black, delay then Blue, delay then Black or frame freeze. The user can specify to show the last good whole frame in which failure happened (useful for diagnostic purposes) or field 1 or 2 of the last frame.

Reset (factory reset and defaults)

These two menus give access to the reset controls that will return all user controlled variables to their factory default values. After initially selecting a reset the user will be asked to confirm this selection.

Note: All user-stored configurations will be erased during a full factory reset.

Parameter	Default value
Mode	Delay
Output Freeze	Off
Output on frozen	Field 1
Output on Input fail	Blue
Output frame rate	Follows Input or 50Hz
Output format	Follows Input
GPI control	Disabled

Preset Menu

Up to eight set-ups may be stored for the board and recalled either from the board control, active front panel, Statesman or through the use of external GPIs. The presets will store board setup data including operating mode and board configuration. The presets are numbered 1-8.

The GPI lines used to recall user saved presets can be disabled to prevent being inadvertently triggered whilst under active control by Statesman or a front panel.

Note: Care should be taken when storing presets, that the desired configuration is not changed by any external input prior to saving.

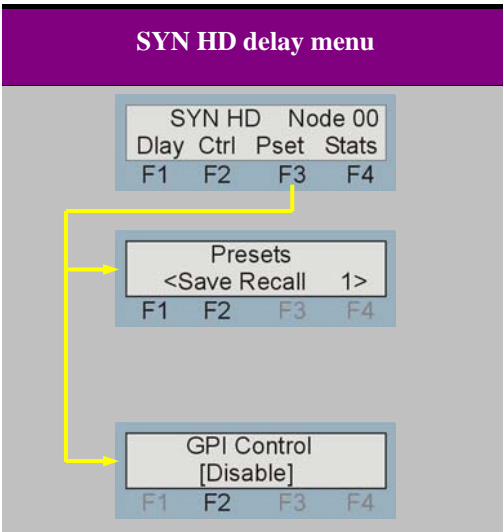
SYN HD delay menu	Description
 <p>The diagram illustrates the navigation sequence for the SYN HD delay menu. It starts with the 'SYN HD Node 00' menu, which has options 'Dlay Ctrl Pset Stats' and function keys 'F1 F2 F3 F4'. A yellow arrow points from 'F3' to the 'Presets' menu. The 'Presets' menu shows '<Save Recall 1>' and 'F1 F2 F3 F4'. A yellow arrow points from 'F1' to the 'GPI Control' menu. The 'GPI Control' menu shows '[Disable]' and 'F1 F2 F3 F4'.</p>	<p>From the Home menu, press F3 to select the Preset menu, which is then traversed by rotating the shaft control.</p> <p>Rotate shaft encoder to select Presets. Press F1 or F2 to initiate selection. Rotate shaft encoder to select the preset location. Press F1 to save current configuration. Press F2 to recall stored configuration.</p> <p>Rotate shaft encoder to select GPI Control. Press F2 to select to change selection. Rotate shaft encoder to select enable or disable. Press enter to accept the new selection.</p>

Status

The status menu contains useful information about the board and its video input.

SYN HD status menu	Description
<pre> graph TD A["SYN HD Node 00 Dlay Ctrl Pset Stats F1 F2 F3 F4"] --> B["Video Standard 525 Int 59.94 F1 F2 F3 F4"] B --> C["Reference Standard 525 Int 59.94 F1 F2 F3 F4"] C --> D["Output Video OP Video Not Frozen F1 F2 F3 F4"] D --> E["Output Delay Less Than Vert Blank F1 F2 F3 F4"] E --> F["Software Level 1.0x F1 F2 F3 F4"] F --> G["Serial Number 000220 F1 F2 F3 F4"] </pre>	<p>From the Home menu, press F4 to select the status menu, which is then traversed by rotating the shaft control.</p> <p>Rotate the shaft control to view the video input status and line rate.</p> <p>Rotate the shaft control to view the reference input status and line rate.</p> <p>Rotate the shaft control to verify the output video is active.</p> <p>Rotate the shaft control to verify if the delay between the external reference and input video is greater than or less than the video-blanking period.</p> <p>Rotate the shaft control to view the currently fitted software version.</p> <p>Rotate the shaft control to view the electronically stored board serial number.</p>

5 Statesman

The Crystal Vision Statesman PC control software is designed to control a range of Crystal Vision modules via serial control from a PC. Statesman provides a user-friendly means of configuring and operating Crystal Vision modules with the benefit of “see-at-a-glance” status monitoring.

The main Statesman application communicates with each module in a frame through a Statesman enabled active control panel. An active panel must be fitted to allow for Statesman control. A second passive frame can be linked to an active frame to create a frame pair, this will increase the number of controllable modules from 12 to 24 per group. The total number of frames and frame pairs connected to a Statesman system will then depend on the chosen control interface i.e. serial 422 or Ethernet.

5.1 Statesman operation

The initial view will show an Explorer style view of the connected frames and modules. Double clicking on a module will enable the display of the main application menus.

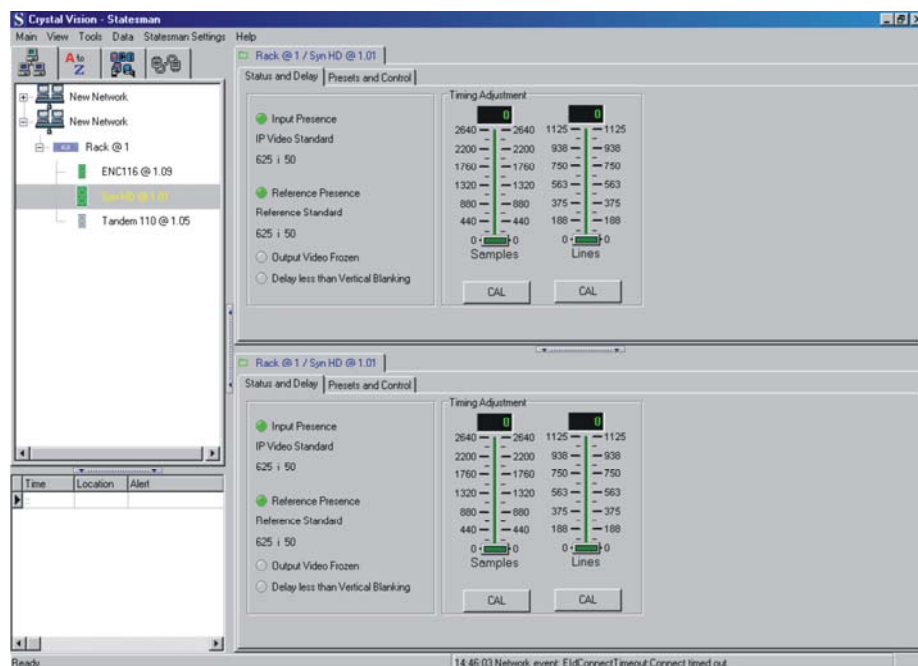

The Statesman main application window

The menu page for convenience is divided into two repeated panes to allow dual-control display of modules with duplicate signal paths or to allow two functions to be viewed at the same time.

SYN HD has two Statesman menu tabs. The Status and Delay pane provides status information and video delay controls. The Preset and Control pane allows board

configuration such as operating mode, output formats, user storable configuration presets and factory reset.

Status and Delay tab

This pane is divided into two group boxes. They are Timing Adjustment and Status.

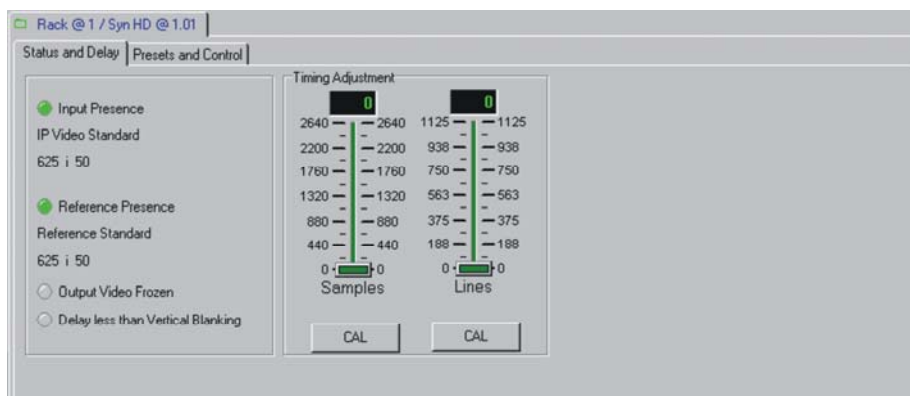

SYN HD Status and Configuration menu

Status

The Status group box gives a quick overview of the SYN HD input status. The presence of input video and external reference is indicated by simulated LEDs. Green will indicate a signal presence. The absence of either input will cause the corresponding LED to show red. The video standard and line rate for both video input and external reference is also given. Should the video output freeze, either due to the Output Freeze being set to ON or through a disruption in the input video, a warning is given by way of the Output Video Frozen LED turning from greyed out to yellow.

When the delay between the external reference and input video is less than the video blanking period the 'Delay less than blanking' LED will illuminate.

Timing Adjustment

The Samples and Lines slider controls are used to adjust the picture horizontal and vertical timing. The minimum delay through the SYN HD with both controls set to zero will be approximately $2\mu\text{s}$, while with both controls set to maximum, the delay available for all HD and SD standards will be one complete frame plus $2\mu\text{s}$. The maximum setting for each slider control is determined by the input video standard. Should a value be set that is beyond this maximum, the video delay will be limited to this maximum and the slide control will automatically return to this maximum value.

Horizontal position timing

The Samples control (Horizontal Position) sets the number of samples/pixels the video is to be delayed by in Delay Mode, or the vertical timing offset with respect to the reference input in Synchro Mode.

Standard	Samples
PAL	0-863
NTSC	0-857
720p 50	0-1979
720p 59.94 / 60	0-1649
1035i 59.94 / 60	0-2199
1080i 50	0-2639
1080i 59.94 / 60	0-2199

Vertical position timing

The Lines control (Vertical Position) sets the number of whole lines the video is to be delayed by in Delay Mode, or the vertical timing offset with respect to the reference input in Synchro Mode.

Standard	Lines
PAL	0-624
NTSC	0-524
720p 50	0-749
720p 59.94 / 60	0-749
1035i 59.94 / 60	0-1124
1080i 50	0-1124
1080i 59.94 / 60	0-1124

Presets and Control tab

Up to eight user configurations may be stored and recalled either from the board edge, active front panel, Statesman or through the use of external GPIs. The presets will store board set-up data including operating mode and board configuration. The presets are numbered 1-8.

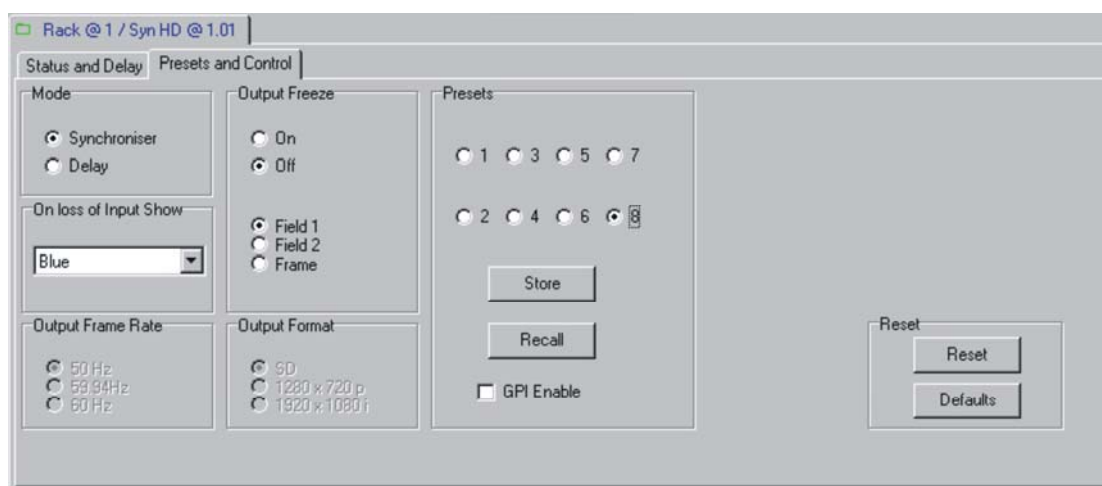

SYN HD Presets and Factory Reset

Selecting the operating Mode

The SYN HD has two modes of operation - synchronisation and delay line. In synchronisation mode the unit takes its timing from the analogue external reference and will automatically synchronise sources between 0 and 2 fields. In delay mode, timing is derived only from the SDI input.

If the input video should contain embedded audio, in delay mode this will be passed along with the video and subject to the delay setting. In synchronising mode there is the likelihood of audio disturbance due to dropped or repeated frames.

Output on Input Failure

Behaviour after a loss of input can be selected from the 'On loss of Input Show' drop down box. The selections are Blue, Black, delay then Blue, delay then Black or Freeze frame. Freeze Frame will show the last good whole frame before the error occurred (useful for diagnostic purposes). Frame, field 1 or 2 can then be selected in the Output Freeze group box.

Output Frame rate and Output Format

These two groups will usually be used in tandem. With neither an external reference or video input present, the SYN HD will initially free run giving an output set by the Output frame, Output format selection and Output on Input Fail selection. The frame rate and format are selected from the options available.

Note: Once video and reference inputs have been applied the output format and frame rate will then match that of the inputs and continue to do so should these subsequently be removed.

Output Freeze

The output can be set to frozen by selecting the Output Freeze to ON. The frozen output condition can then be selected.

The type of freeze is selected by checking the appropriate radio button, the selection being Frame, Field 1 or Field 2. The field selections can be useful when there is movement between both fields where a frame freeze will show movement judder. A field freeze works by repeating the same field to produce a synthetic frame of video, without movement judder. However a field freeze is more likely to show jagged edges on near horizontal lines.

Presets

Up to eight set-ups may be stored for the board and recalled either from the board control, active front panel, Statesman or through the use of external GPIs. The presets will store board setup data including operating mode and board configuration.

The GPI lines used to recall user saved presets can be disabled to prevent inadvertent triggering whilst under active control by Statesman or a front panel.

Note: Care should be taken when storing presets that the desired configuration is not changed by any external input prior to saving.

Reset (factory defaults)

The user has the choice of performing a total factory reset or a partial reset. Pushing the Reset button will return all parameters to their factory default values and erase all user stored configuration presets. Selecting the Defaults option will perform the same reset to factory defaults values but will leave any user stored configurations unaffected.

Parameter	Default value
Mode	Synchroniser
Output Freeze	Off
Output on frozen	Field 1
Output on Input fail	Blue
Output frame rate	Follows Input or 50Hz
Output format	Follows Input
GPI control	Disabled

6 Trouble shooting

Simple trouble shooting can be performed by using either the card edge or a remote status panel display.

6.1 Card edge status LEDs

Board edge LEDs provide status reporting and may be useful when fault finding.

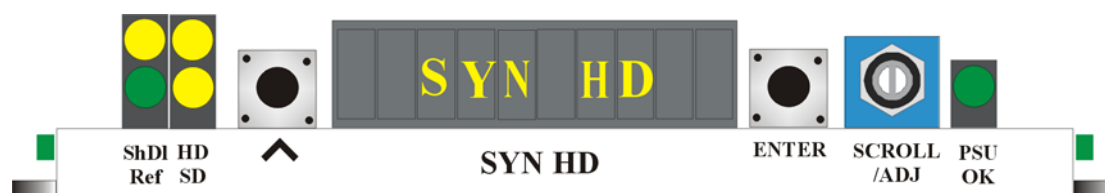

The following table summarises the card edge LED functions and colours:

Name	LED Colour	Function when ON	Function when Off
HD	Yellow	Video input standard is HD (High Definition)	} Input not present
SD	Yellow	Video input standard is SD (Standard Definition)	
PSU	Green	Good power supply (PSU) rails.	One or more of the monitor supplies is out of specification
ShDI	Yellow	Short Delay (within blanking)	Delay longer than blanking period
nCal	Green	External reference present	No external reference present

The board edge display may also give some useful information when trouble shooting

Basic fault finding guide

The Power OK LED is not illuminated

Check that the frame PSU is functioning – refer to the appropriate frame manual for detailed information.

There is no video output

Check that a valid input is present and that any cabling is intact. Use the board edge, active control panel or Statesman status information to determine a likely fault.

The video output exhibits jitter

Check that the input signal stability is within normal limits and that the maximum cable length has not been exceeded.

The card no longer responds to card edge or front panel control

Check that the card is seated correctly and that the Power OK LED is lit.

Check any active control panel cabling.

Check if the control panel can control another card in the same rack.

If necessary re-set the card by simply removing it from the rack whilst powered and re-inserting it after a few seconds. It is safe to re-insert the card whilst the rack is powered.

7 Specification

General

Dimensions	100mm x 266 mm module with DIN 41612 connector
Weight	185g
Power consumption	4 W

Inputs

Video	HD or SD SDI 270Mb/s to 1.485Gb/s serial digital compliant to SMPTE-259M and SMPTE-292M Cable equalisation, Belden 8281 or equivalent HD (1.485Gb/s) – 100 metres SD (270Mb/s) >250 metres
-------	---

Outputs

Number and type:	4 reclocked SDI outputs 270Mb/s - 1.485Gb/s to SMPTE-259M and SMPTE- 292M (2 x scaler outputs and 2 x input loop-through) Belden 8281 or equivalent HD (1.485Gb/s) – 100 metres SD (270Mb/s) >250 metres
Jitter	Typically SD 0.2UI @ 1kHz, HD 0.2UI @ 100kHz

Processing

10 bit. Active picture only.
0-2 fields of variable delay
TTL Audio tracking pulse output
4 x GPI inputs for presets recall 2x GPI output for external reference input missing and Audio tracking pulse